

KENWOOD

AUDIO VIDEO SURROUND RECEIVER

KRF-V8030D VR-409

INSTRUCTION MANUAL

KENWOOD CORPORATION

This instruction manual is used to describe multiple models listed above. Model availability and features (functions) may differ depending on the country and sales area.

About the supplied remote control (RC-R0809)...

Compared to standard remote controls, the remote control supplied with this receiver has several operation modes. These modes enable the remote control to control other audio/video components. In order to effectively use the remote control it is important to read the operating instructions and obtain a proper understanding of the remote control and how to switch its operation modes (etc.).

Using the remote control without completely understanding its design and how to switch the operation modes may result in incorrect operations.

Preparation

Operations

Other

Remote Control

Before applying the power

⚠ Caution : Read this page carefully to ensure safe operation.

2

Units are designed for operation as follows.

- U.S.A. and Canada** **AC 120 V only**
- Australia** **AC 240 V only**
- China and Russia** **AC 220 V only**
- *Other countries** **AC 110-120 / 220-240 V switchable**

Preparations

* AC voltage selection

The AC voltage selector switch on the rear panel is set to the voltage that prevails in the area to which the unit is shipped. Before connecting the power cord to your AC outlet, make sure that the setting position of this switch matches your line voltage. If not, it must be set to your voltage in accordance with the following direction.

AC voltage selector switch

Move switch lever to match your line voltage with a small screw-driver or other pointed tool.

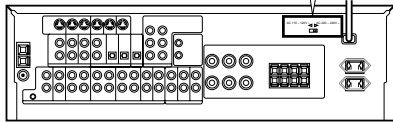
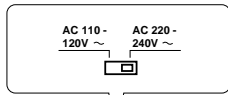

Note:
Our warranty does not cover damage caused by excessive line voltage due to improper setting of the AC voltage selector switch.

Unpacking

Unpack the unit carefully and make sure that all accessories are put aside so they will not be lost. Examine the unit for any possibility of shipping damage. If your unit is damaged or fails to operate, notify your dealer immediately. If your unit was shipped to you directly, notify the shipping company without delay. Only the consignee (the person or company receiving the unit) can file a claim against the carrier for shipping damage. We recommend that you retain the original carton and packing materials for use should you transport or ship the unit in the future.

Keep this manual handy for future reference.

Accessories

FM indoor antenna (1)

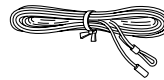

AM loop antenna (1)

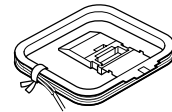

Remote control unit (1)



Batteries (R6/AA) (4)

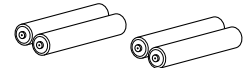

*AC plug adaptor (1)

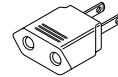

*Use to adapt the plug on the power cord to the shape of the wall outlet. (Accessory only for regions where use is necessary.)

Safety precautions

WARNING :

TO PREVENT FIRE OR ELECTRIC SHOCK, DO NOT EXPOSE THIS APPLIANCE TO RAIN OR MOISTURE.



CAUTION
RISK OF ELECTRIC SHOCK
DO NOT OPEN



CAUTION: TO REDUCE THE RISK OF ELECTRIC SHOCK, DO NOT REMOVE COVER (OR BACK). NO USER-SERVICEABLE PARTS INSIDE, REFER SERVICING TO QUALIFIED SERVICE PERSONNEL.





THE LIGHTNING FLASH WITH ARROWHEAD SYMBOL, WITHIN AN EQUILATERAL TRIANGLE, IS INTENDED TO ALERT THE USER TO THE PRESENCE OF UNINSULATED "DANGEROUS VOLTAGE" WITHIN THE PRODUCT'S ENCLOSURE THAT MAY BE OF SUFFICIENT MAGNITUDE TO CONSTITUTE A RISK OF ELECTRIC SHOCK TO PERSONS.



THE EXCLAMATION POINT WITHIN AN EQUILATERAL TRIANGLE IS INTENDED TO ALERT THE USER TO THE PRESENCE OF IMPORTANT OPERATING AND MAINTENANCE (SERVICING) INSTRUCTIONS IN THE LITERATURE ACCOMPANYING THE APPLIANCE.

Contents

Caution : Read the pages marked  carefully to ensure safe operation.

Preparations	 Before applying the power 2	Preparations
	 Safety precautions 2	
	Unpacking 2	
	How to use this manual 4	
	Special features 4	
	Names and functions of parts 5	
	Setting up the system 7	
	Connecting audio components 7	
	Connecting video components 8	
	Connecting a DVD player 8	
	Digital connections 9	
	Connecting to the AUX IN jacks 10	
	Connecting the antennas 10	
	Connecting the system control 11	
Connecting the speakers 12		
PRE OUT connections 12		
Channel space switching 13		
Preparing the remote control 13		
Preparing for surround sound 14		
Speaker settings 14		
<hr/>		
Operations	Normal playback 16	Operations
	Preparing for playback 16	
	Listening to a source component 16	
	Adjusting the sound 17	
	Recording 18	
	Recording audio (analog sources) 18	
	Recording video 18	
	Recording audio (digital sources) 18	
	Listening to radio broadcasts 19	
	Tuning radio stations 19	
	Presetting radio stations manually 20	
	Receiving preset stations 20	
	Receiving preset stations in order (P.CALL) 20	
	Ambience effects 21	
Surround modes 21		
Surround play 23		
DVD 6-channel playback 24		
Convenient functions 24		
<hr/>		
Other	In case of difficulty 26	Other
	 Specifications 27	
<hr/>		
Remote Control	Quick start guide 29	Remote Control
	Getting the most from your remote control 31	
	Remote operation of other components ... 39	
	In case of difficulty 42	



As an ENERGY STAR® Partner, Kenwood Corporation has determined that this products meets the ENERGY STAR® guidelines for energy efficiency.

This product can save energy. Saving energy reduces air pollution and lowers utility bills.

Maintenance of the unit

When the front panel or case becomes dirty, wipe with a soft, dry cloth. Do not use thinner, benzine, alcohol, etc. for these agents may cause discoloration.

In regard to contact cleaner

Do not use contact cleaners because it could cause a malfunction. Be specially careful not to use contact cleaners containing oil, for they may deform the plastic component.

How to use this manual

This manual is divided into four sections, Preparations, Operations, Other, and Remote Control.

Preparations

Shows you how to connect your audio and video components to the receiver and prepare the surround processor.

We've tried to make setting up your system as easy as possible. However, since this receiver works with all of your audio and video components, connecting the system can be fairly complex.

Operations

Shows you how to operate the various functions available from the receiver.

Other

Shows you additional information such as "In case of difficulty" (trouble-shooting) and "Specifications".

Remote Control (Separate booklet)

Includes the "Quick Start Guide," which shows you how to operate other components using the remote control, as well as a detailed explanation of all remote control operations. Once you have registered your components with the proper setup codes, you'll be able to operate both this receiver and your other AV components (TV, VCR, DVD player, LD player, CD player, etc.) using the remote control supplied with this receiver.

Special features

True home theater sound

This receiver incorporates a wide variety of surround modes to bring you maximum enjoyment from your video software. Select a surround mode according to your equipment or the software you are going to play and enjoy!
—[21]

Dolby Pro Logic & Dolby 3 Stereo

This surround system reproduces theater-like surround sound from video software marked .

The PRO LOGIC mode uses the built-in adaptive matrix circuit to steer the Left, Center, Right and Surround channel audio signals.

The 3 STEREO mode will redirect the Surround signal to the front left and right speakers when only the front and center speakers are used.

Dolby Digital (AC-3)

The DOLBY DIGITAL (AC-3) mode lets you enjoy full digital surround from software processed in the Dolby Digital (AC-3) format. Dolby Digital (AC-3) provides up to 5.1 channels of independent digital audio for better sound quality and more powerful presence than conventional Dolby Surround.

DTS

DTS (Digital Theater System) is a 5.1 channel digital audio format that provides five full-spectrum channels and one low-frequency (subwoofer) channel for unprecedented clarity, optimum channel separation and a (wide) dynamic range.

In the DTS mode, the 5.1 channel digital input from a DTS CD, LD or DVD disc (carrying the "DTS" marking) can be played in Digital Surround.

Important:

When a DTS disc is played on a CD, LD or DVD player, noise may be output from the analog output. It is recommended that you connect the digital output of the player to the digital input of this unit.

Multi channel music (SRS Circle Surround (●)CS)

SRS Circle surround enables you to listen to multi channel sound from the stereo source. We assume you have already enjoyed listening to Dolby digital sound/DTS multi channel sound with your multi speakers. Now, this time try listening to the stereo source (ex. Audio CD) using your multi speakers. You may discover a new type of "stereo" sound through SRS Circle Surround.

New DSP surround modes

The DSP (Digital Signal Processor) used for this receiver incorporates a variety of high quality adjustable sound fields, like "ARENA" and "THEATER". It is compatible with almost any kind of program source.

DVD 6-channel input

If you own a DVD player equipped with 6-channel output, this receiver allows you to obtain the full surround sound impact of DVD source material featuring multi-channel encoding. Since the source signals are digital and each channel is input independently, the resulting ambience is far superior to what can be achieved with conventional surround sound systems.

Universal IR (InfraRed) remote control

In addition to the basic receiver, the remote control supplied with this receiver can also operate almost all of your remote controllable audio and video components. Just follow the simple setup procedure to register the components you have connected.

MACRO play

The MACRO function lets you perform a series of operations automatically, like turning ON the power of the receiver and connected components, switching the input selectors, and starting playback. (Be sure to register your components before starting the macro set up procedure.)

Memory back up function

Please note that the following items will be deleted from the unit's memory if the power cord is disconnected from the AC outlet for approximately 3 days.

- Power mode.
- Input selector settings.
- Device preset.
- Picture output.
- Speaker ON/OFF
- Volume level.
- BASS, TREBLE, INPUT level.
- Subwoofer ON/OFF.
- Dimmer level.
- Monitor ON/OFF.
- MD/TAPE settings.
- 6CH/2CH input setting.
- Listen mode setting.
- Speaker settings.
- Input mode setting.
- Midnight mode setting.
- Broadcast band.
- Frequency setting.
- Preset stations.
- Tuning mode.

Names and functions of parts

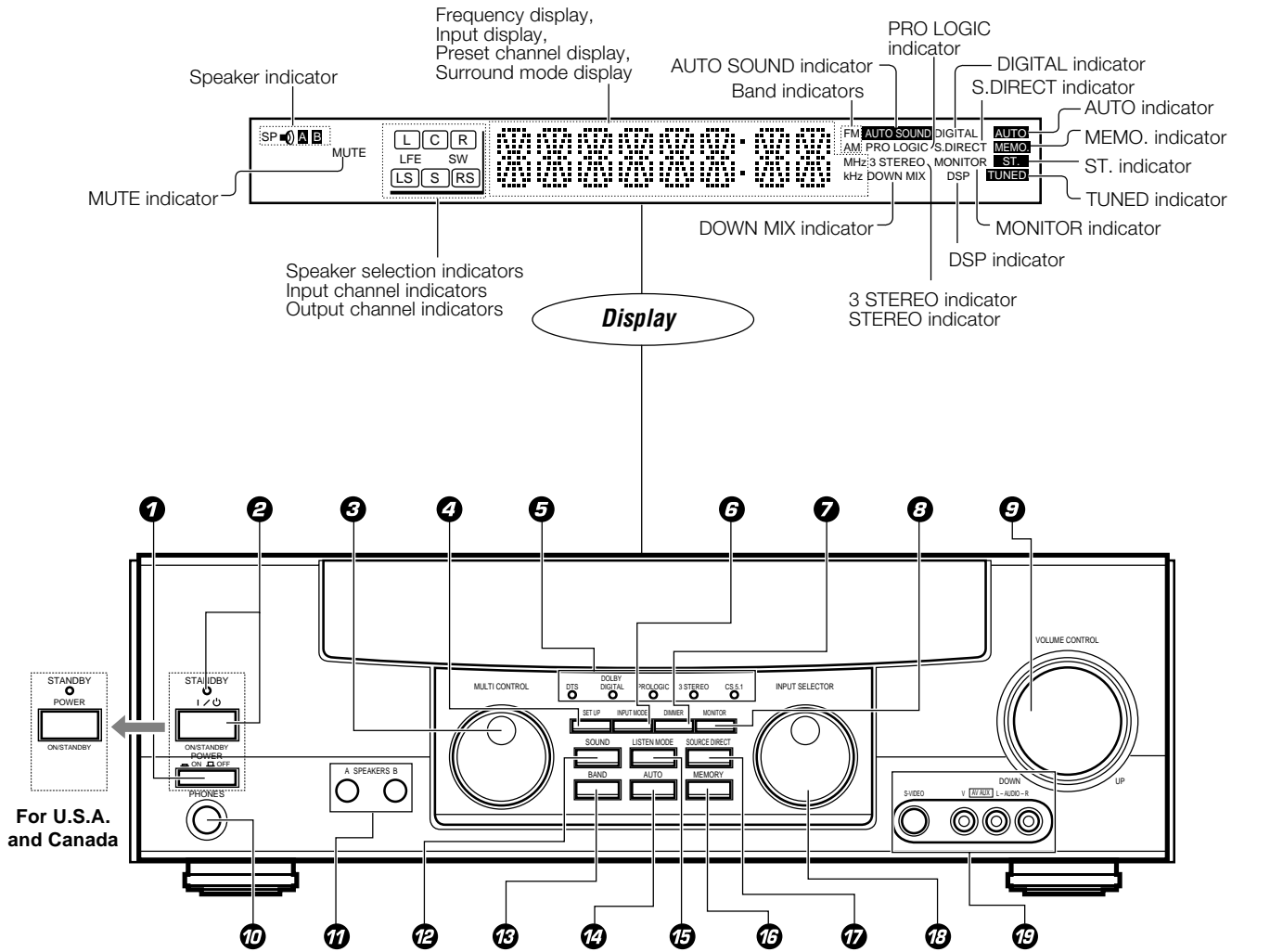

- 1 POWER key** (Except for U.S.A. and Canada) - 14
Use to turn the main power ON/OFF.
- 2 POWER key** (For U.S.A. and Canada) - 14
Use to turn the power ON/OFF.
- 3 STANDBY indicator**
- 4 ON/STANDBY (I/⏻) key** (Except for U.S.A. and Canada) - 14
Use to switch the power ON/STANDBY when the POWER is turned ON.
- 5 STANDBY indicator**
- 6 MULTI CONTROL knob** - 14
Used to make a variety of settings.
- 7 SET UP key** - 14
Use to select the surround sound settings.
- 8 Surround indicators**
- 9 DTS indicator** - 23
Lights when the receiver is in the DTS mode.
- 10 DOLBY DIGITAL indicator** - 23
Lights when the receiver is in the Dolby Digital mode.
- 11 PROLOGIC indicator** - 23
Lights when the receiver is in the PROLOGIC mode.
- 12 3 STEREO indicator** - 23
Lights when the receiver is in the 3 STEREO mode.
- 13 CS 5.1 indicator** - 23
Lights when the receiver is in the CS 5.1 mode.
- 14 INPUT MODE key** - 9
Use to switch between the digital and analog inputs.
- 15 DIMMER key** - 18 - 25
Use to adjust the brightness of the display.
- 16 MONITOR key** - 18
Use to monitor the source that is connected to the MONITOR jack.
- 17 VOLUME CONTROL knob** - 17
- 18 PHONES jack** - 17
Use for headphone listening.
- 19 SPEAKERS A/B keys** - 17
Use to turn the A/B speakers ON/OFF.
- 20 SOUND key** - 17
Use to adjust the sound quality and ambience effects.
- 21 BAND key** - 19
Use to select the broadcast band.
- 22 AUTO key** - 19
Use to select the auto tuning mode.
- 23 LISTEN MODE key** - 23
Use to select the listening mode.
- 24 MEMORY key** - 20
Use to store radio stations in the preset memory.
- 25 SOURCE DIRECT key** - 17
Use to pass the source material direct to the amplifier.
- 26 INPUT SELECTOR knob** - 16
Use to select the input sources.
- 27 AV AUX (S VIDEO/VIDEO/AUDIO L/R) jacks** - 10

Standby mode

While the standby indicator of the unit is lit, a small amount of current is flowing into the unit's internal circuitry to back up the memory. This condition is referred to as the standby mode of the unit. While the unit is in the standby mode, it can be turned ON from the remote control unit.

Remote control unit

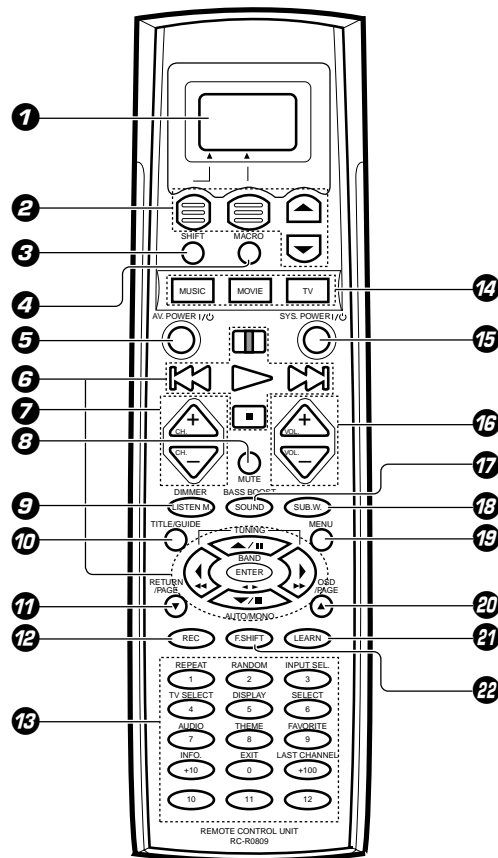

Page references such as “RC-11” indicate pages in the remote control operation manual (Separate booklet).

- 1 **Display** RC-11
- 2 **Display operation keys** RC-11
Used for operation on the display.
- 3 **SHIFT key** RC-5
Use in combination with the MUSIC and MOVIE keys to change the remote control mode without changing the input selector.
- 4 **MACRO key** RC-6
Use in combination with the MUSIC, MOVIE, or TV keys to execute a series of commands automatically (MACRO PLAY).
- 5 **AV.POWER I/O key**
Use to turn various components on and off.
- 6 **Multi control keys** RC-11
Used to make a variety of settings. Use to operate other components.
- 7 **CH +/- keys** RC-11
Use to select the channel.
- 8 **MUTE key** -17
Use to temporarily mute the sound.
- 9 **LISTEN M. key** -23
Use to select the listening mode.
DIMMER key (with F.SHIFT key) -18 -25
Use to adjust the brightness of the display.
Use to select the REC MODE.
- 10 **TITLE/GUIDE key** RC-12
Use to operate other components.

- 11 **RETURN/PAGE key** RC-12
Use to operate other components.
- 12 **REC key** RC-11
Use to operate the selected component.
- 13 **Numeric keys/Source operation keys** RC-11
Provide functions identical to those of the original remote control supplied with the component you are controlling. To access the functions printed above the keys, press the numeric key after pressing the F. SHIFT key. Function availability varies for each component.
- 14 **MUSIC key** -16
Selects the video inputs and sets the remote control to operate the component registered at the respective input. If you connect audio components from KENWOOD and other makers to the MD/TAPE or CD jacks, you can set the remote control to operate these components by registering the appropriate setup code at the respective input.
MOVIE key -16
Selects the video inputs and sets the remote control to operate the component registered at the respective input.
TV key
Sets the remote control to operate a TV or

There are some cases in which keys (or knobs) that have the same function on the receiver and on the remote control have different names. In the instructions of this manual, if the names of corresponding keys (or knobs) on the receiver and remote control are different, the name of the remote control key is indicated in parentheses.

- cable box. This key does not change the input selector on the receiver.
- 15 **SYS.POWER I/O key** -16
Use to turn the receiver on and off.
- 16 **VOLUME +/- keys** -16
Use to adjust the receiver volume.
- 17 **SOUND key** -24
Use to adjust the sound quality and ambience effects.
BASS BOOST key (with F.SHIFT key) -17
Use to select the maximum adjustment setting for the low frequency range.
- 18 **SUB W. key** -25
Use in combination with the VOLUME +/- keys to adjust the volume of the subwoofer.
- 19 **MENU key** RC-12
Use to operate other components.
- 20 **OSD/PAGE key** RC-12
Use to operate other components.
- 21 **LEARN key** RC-8
Use to memorize the operation of the other remote control units.
- 22 **F. SHIFT key** RC-11
Use in combination with the numeric keys to execute alternate commands. Turn the light of the display on and off by pressing and holding this key for more than 2 seconds.

Setting up the system

Make connections as shown below.
When connecting the related system components, be sure to also refer to the instruction manuals supplied with the components you are connecting.
Do not connect the power cord to a wall outlet until all connections are completed.

DTS disclaimer clause

DTS Digital Surround™ is a discrete 5.1 channel digital audio format available on CD, LD, and DVD software which consequently cannot be decoded and played back inside most CD, LD, or DVD players. For this reason, when DTS-encoded software is played back through the analog outputs of the CD, LD, or DVD player, excessive noise will be exhibited. To avoid possible damage to the audio system, proper precautions should be taken by the consumer if the analog outputs are connected directly to an amplification system. To enjoy DTS Digital Surround™ playback, an external 5.1 channel DTS Digital Surround™ decoder system must be connected to the digital output (S/P DIF, AES/EBU, or TosLink) of the CD, LD or DVD player. This unit is equipped with DTS Digital Surround™ decoder.

Notes

1. Be sure to insert all connection cords securely. If their connections are imperfect, the sound may not be produced or noise may interfere.
2. Be sure to remove the power cord from the AC outlet before plugging or unplugging any connection cords. Plugging/unplugging connection cords without disconnecting the power cord can cause malfunctions and may damage the unit.
3. Do not connect power cords from components whose power consumption is larger than what is indicated on the AC outlet at the rear of this unit.

Analog connections

Audio connections are made using RCA pin cords. These cables transfer stereo audio signal in an "analog" form. This means the audio signal corresponds to the actual audio of two channels. These cables usually have 2 plugs each end, one red for the right channel and one white for the left channel. These cables are usually packaged with the source unit, or are available at your local electronics retailer.

Microcomputer malfunction

If operation is not possible or an erroneous display appears, even though all connections have been made properly, reset the microcomputer referring to "In case of difficulty".

CAUTION (Except for U.S.A. and Canada)

Be sure to adhere followings. Or proper ventilation will be blocked causing damage or fire hazard.

- Install the KRF-V8030D on the top of the system.
- Do not place any objects impairing heat radiation onto the top of unit.
- Leave a space around the unit (from the largest outside dimension including projection) equal or greater than, shown below.

Top panel : 50 cm Side panel : 10 cm Back panel : 10 cm

CAUTION (For U.S.A. and Canada)

Be sure to adhere followings. Or proper ventilation will be blocked causing damage or fire hazard.

- Install the VR-409 on the top of the system.
- Do not place any objects impairing heat radiation onto the top of unit.

Connecting audio components

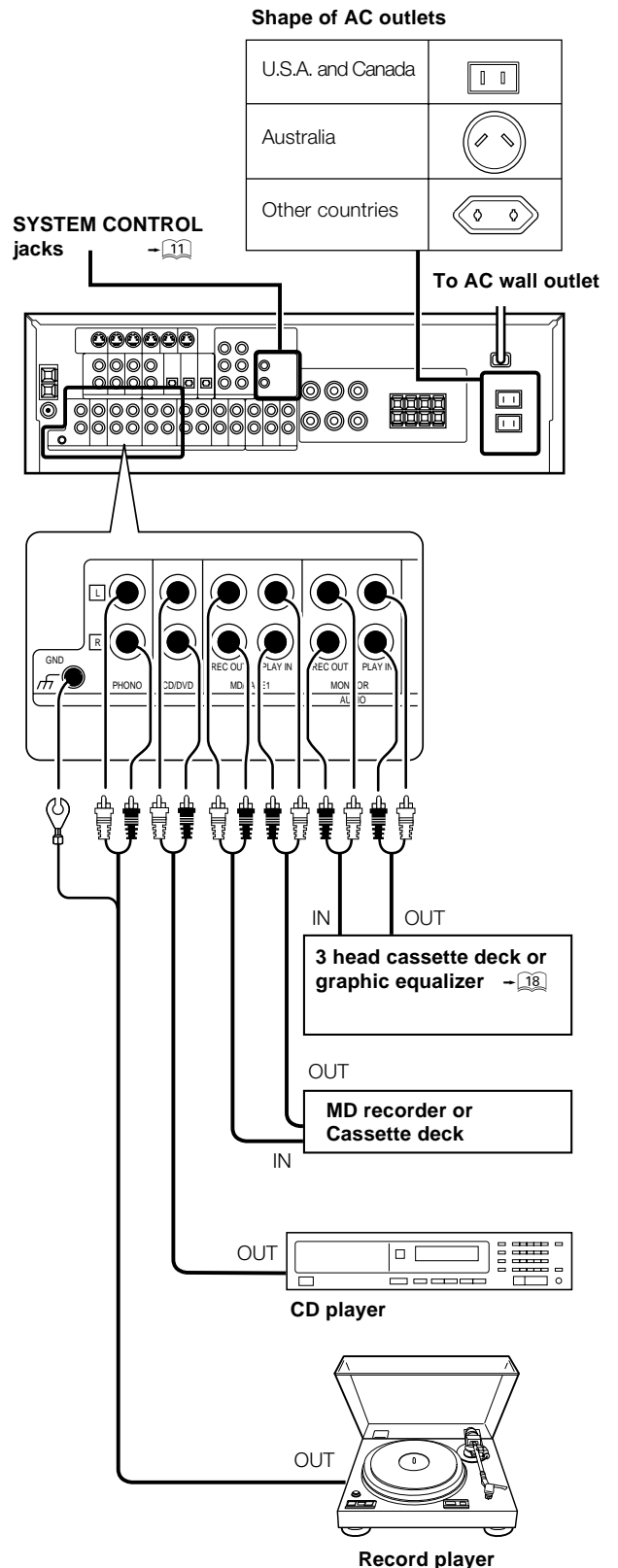

When you connect the unit and the CD or MD player with the digital connection, you can enjoy the higher sound quality.

Connecting video components

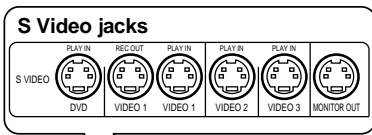

About the S VIDEO jacks

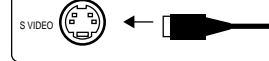

Use the S VIDEO jacks to make connections to video components with S VIDEO IN/OUT jacks.

- If you use the S VIDEO jacks to connect your video playback components, be sure to use the S VIDEO jacks when connecting your monitor and video recording components.

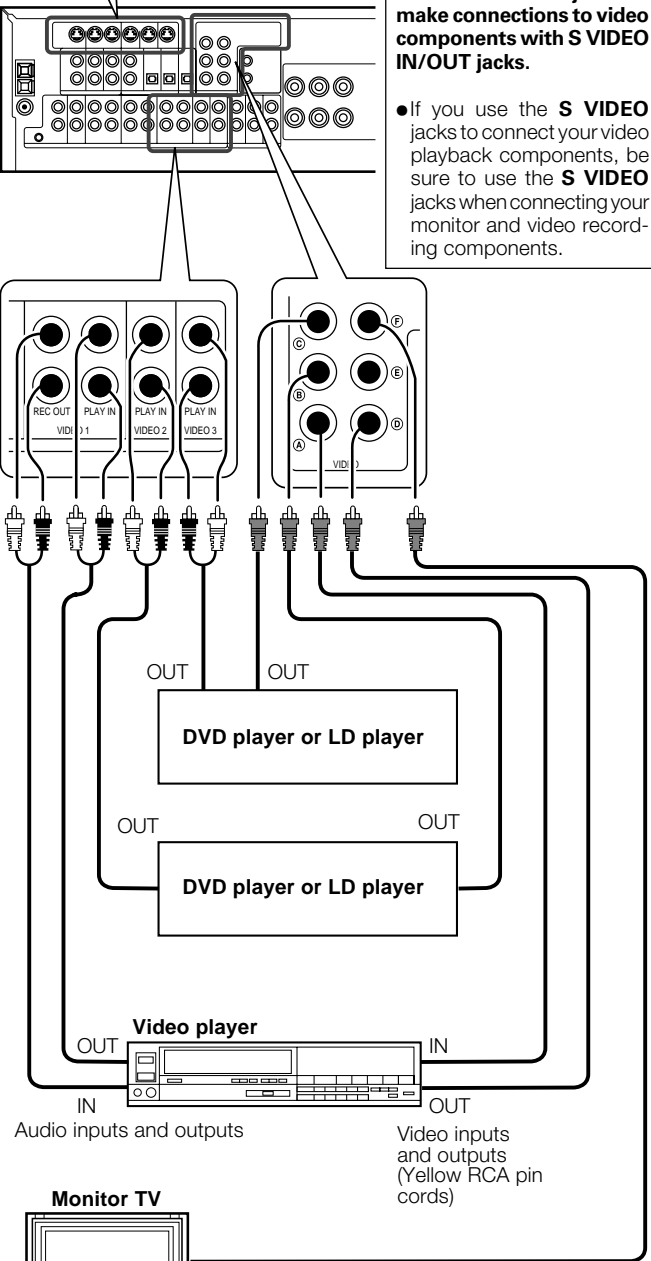

A video component with digital audio outputs should be connected to the VIDEO2 or VIDEO3 jacks.

Connecting a DVD player (6-channel input)

If you have connected a DVD player to the receiver with digital connection, be sure to read the "Input mode settings" section on the following page carefully.

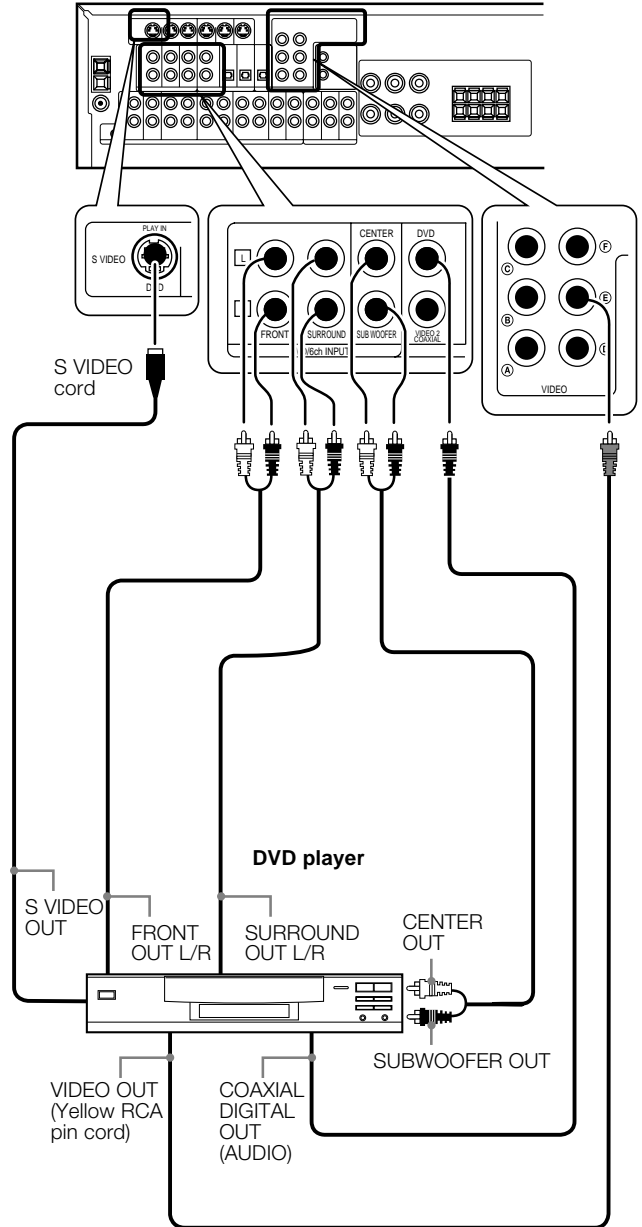

To switch the speakers off, press the MUTE key.

Digital connections

The digital in jacks can accept DTS, Dolby Digital (AC-3), or PCM signals. Connect components capable of outputting DTS, Dolby Digital (AC-3), or standard PCM (CD) format digital signals.

If you have connected any digital components to the receiver, be sure to read the "Input mode settings" section on this page carefully.

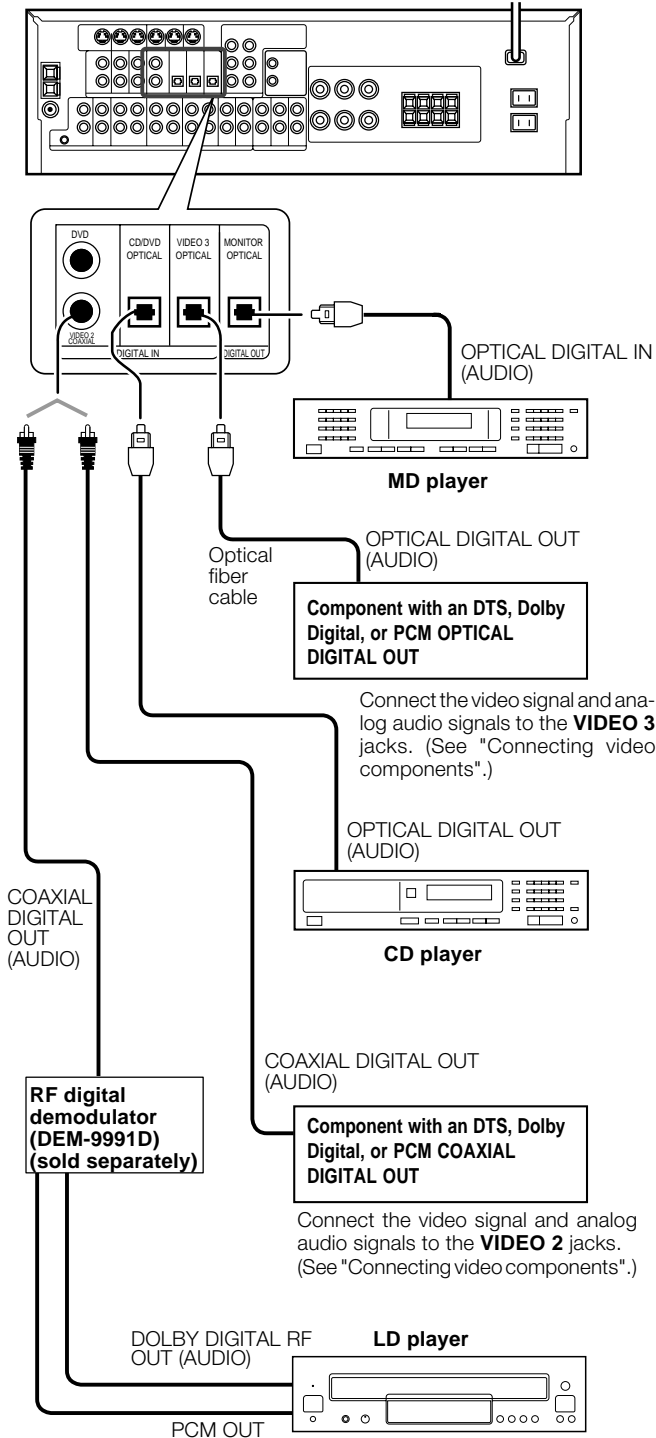

To connect an LD player with a DIGITAL RF OUT, connect the LD player to the KENWOOD RF digital demodulator (DEM-9991D). Next, connect the DIGITAL OUT jacks of the demodulator to the DIGITAL IN jacks of the receiver. Connect the video signal and analog audio signals to the VIDEO 2 or VIDEO 3 jacks. (See "Connecting video components".)

Input mode settings

CD, DVD, VIDEO2, and VIDEO3 inputs each include jacks for digital audio input and analog audio input.

You must select beforehand which type of input is to be used for each connected component.

The initial factory setting is to use the digital audio signal for playback (CD, DVD, VIDEO2, VIDEO3).

To use the analog audio input for playback instead (if, for example, you have connected a VCR to the VIDEO2 or VIDEO3 input), you must set the input mode for the corresponding input to the analog mode.

After completing connections and turning on the receiver, follow the steps below.

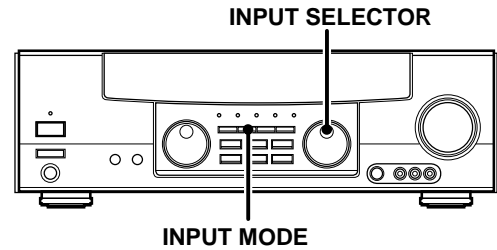

❶ Use the **INPUT SELECTOR** knob to select **CD, DVD, VIDEO2, or VIDEO3**.

❷ Press the **INPUT MODE** key.

Each press switches the setting as follows:

In DTS play mode

- ❶ **D-AUTO** (digital input, auto sound)
- ❷ **D-MANUAL** (digital input, manual sound)

In DVD play mode

- ❶ **D-AUTO** (digital input, auto sound)
- ❷ **D-MANUAL** (digital input, manual sound)
- ❸ **6CH INPT** (DVD 6CH input)
- ❹ **ANALOG** (analog input, manual sound)

In other mode than DTS or DVD play mode

- ❶ **D-AUTO** (digital input, auto sound)
- ❷ **D-MANUAL** (digital input, manual sound)
- ❸ **ANALOG** (analog input, manual sound)

Digital input:

Select this setting to play digital signals from a DVD, CD, or LD player.

Analog input:

Select this setting to play analog signals from a cassette deck, VCR, or turntable.

Auto sound:

In the auto sound mode (**AUTO SOUND** indicator lights), the receiver selects the listening mode automatically during playback to match the type of input signal (Dolby Digital, PCM, DTS) and the speaker setting. The initial factory setting is auto sound on.

To keep the receiver set to the currently selected listening mode, use the **INPUT MODE** key to select "**D-MANUAL**" (manual sound). However, even when this setting is selected, there may be cases in which the listening mode is selected automatically to match a Dolby Digital source signal depending on the combination of listening mode and source signal.

Connecting to the AUX IN jacks

The **AUX IN** jacks are convenient for connection of video components such as a camcorders and video games.

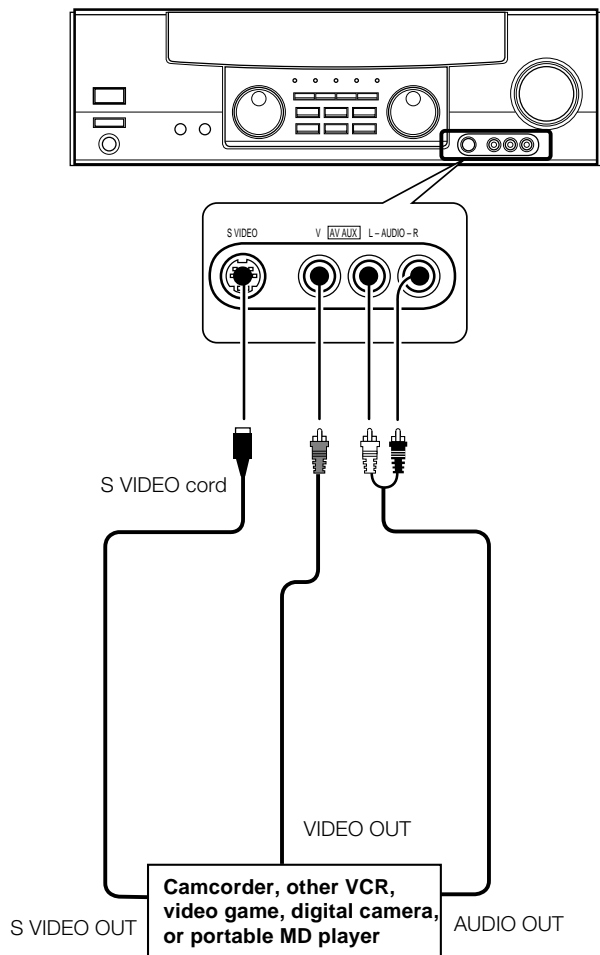

- To select the source connected to the AUX IN jacks, select AV AUX by using the INPUT SELECTOR knob. — 16
- When you connect the audio source such as the MD player, you do not need to connect the video cable.
- When you connect the unit and the component with the S VIDEO cord, you can get better picture quality.

Connecting the antennas

AM loop antenna

The supplied loop antenna is for use indoors. Place it as far as possible from the receiver, TV set, speaker cords and power cord, and adjust the direction for best reception.

AM antenna terminal connections

- 1 Push lever.
- 2 Insert cord.
- 3 Return lever.

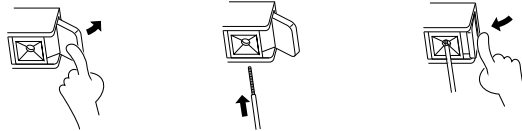

FM indoor antenna

The supplied indoor antenna is for temporary use only. For stable signal reception we recommend using an outdoor antenna. Disconnect the indoor antenna when you connect one outdoors.

FM outdoor antenna

Lead the 75Ω coaxial cable connected to the FM outdoor antenna into the room and connect it to the **FM 75Ω** terminal.

FM antenna terminal connections

- Insert cord.

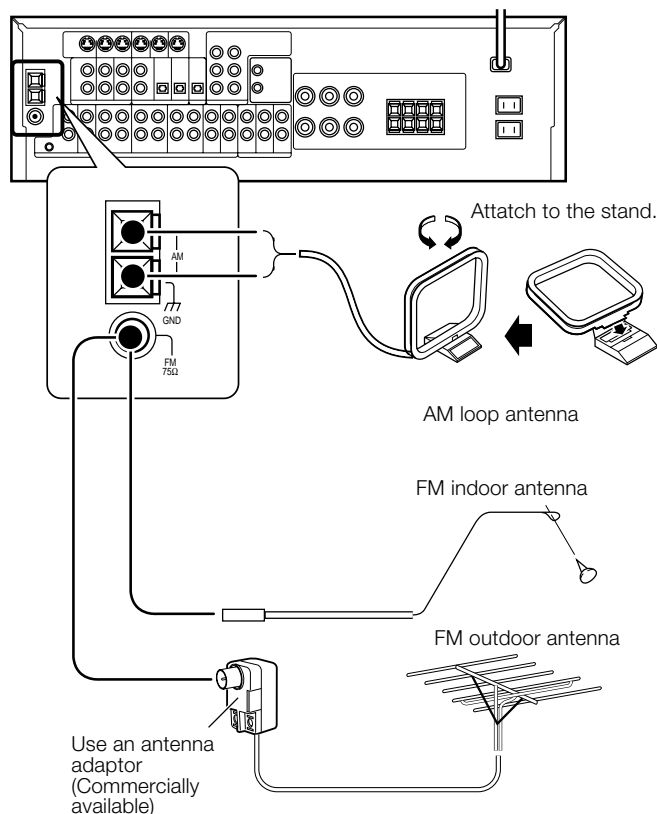

Connecting the system control

Connecting system control cords after connecting a KENWOOD audio component system lets you take advantage of convenient system control operations.

This unit is compatible only with the [SL-16] mode. The system control operation is not available if the unit is connected in the [XS-8], [XS] or [XR] connection mode.

If your component has the mode select switch, set the connected components to the [SL-16] mode.

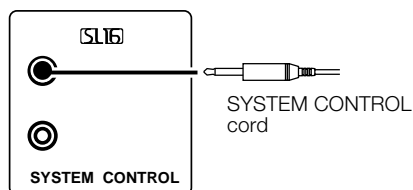

EXAMPLE: [SL16] mode connections

The underlined portion represents the setting of the system control mode.

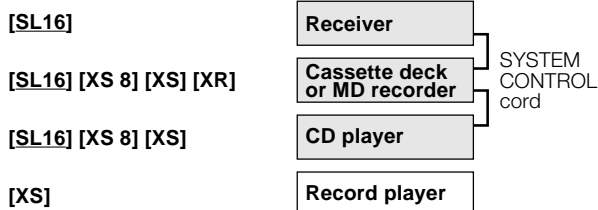

- In order to take advantage of the system control operations, the components must be connected to the correct jacks. To use a CD player it must be connected to the CD jacks. To use a cassette deck (or MD recorder) it must be connected to the MD/TAPE jacks. When using more than one CD player (etc.) only the one connected to the specified jacks may be connected for system control.
- Some CD players and cassette decks are not compatible with the [SL16] system control mode. Do not make system connections with equipment that is not [SL16] compatible.
- Some MD players are not system control compatible. You cannot make system control connections to this kind of equipment.

Notes

1. [SL16] equipment cannot be combined with [XR], [XS], and [XS8] equipment for system operations. If your equipment consists of this kind of combination, please do not connect any system control cords. Even without system control cords, normal operations can be carried out without effecting performance.
2. Do not connect system control cords to any components other than those specified by KENWOOD. It may cause a malfunction and damage your equipment.
3. Be sure the system control plugs are inserted all the way in to the system control terminals.

Do not connect a system control cord to a cassette deck connected to the MONITOR jacks.

SYSTEM CONTROL OPERATIONS

Remote Control

Lets you operate this unit with the system remote supplied with the receiver.

Automatic Operation

When you start playback from a source component, the input selector on this unit switches to that component automatically.

Synchronized Recording

Lets you synchronize recording with the start of playback when recording from CD, MD or analog discs.

Registering setup codes for KENWOOD audio components

- Once you finish making the system connections, be sure to register the appropriate setup code for each component. **RC-3**
- If you own remote controllable KENWOOD audio components that are not compatible with system control, registering the setup code enables you to control those components using the remote control supplied with this unit (without connecting system control cords). To register setup codes for your remote controllable KENWOOD audio components, see "Registering setup codes for other components". **RC-3**

Connecting the speakers

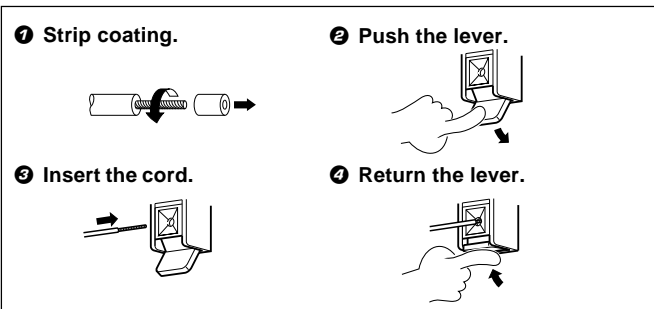
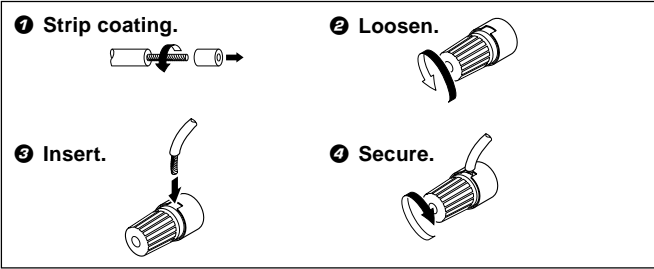

Connection of banana plugs (For U.S.A. and Canada)

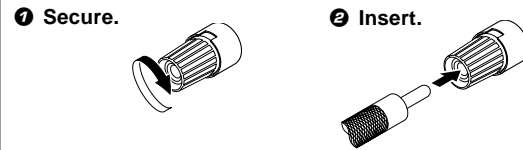

- Sound will not be heard if the speaker terminal is not fully secured.
- Never short circuit the + and – speaker cords.
- If the left and right speakers are connected inversely or the speaker cords are connected with reversed polarity, the sound will be unnatural with ambiguous acoustic imaging. Be sure to connect the speakers correctly.

Speaker impedance

After confirming the speaker impedance indications printed on the rear panel of the receiver, connect speakers with matching impedance ratings. Using speakers with a rated impedance other than that indicated on the rear panel of the receiver could result in malfunctions or damage to the speakers or receiver.

Front Speakers A

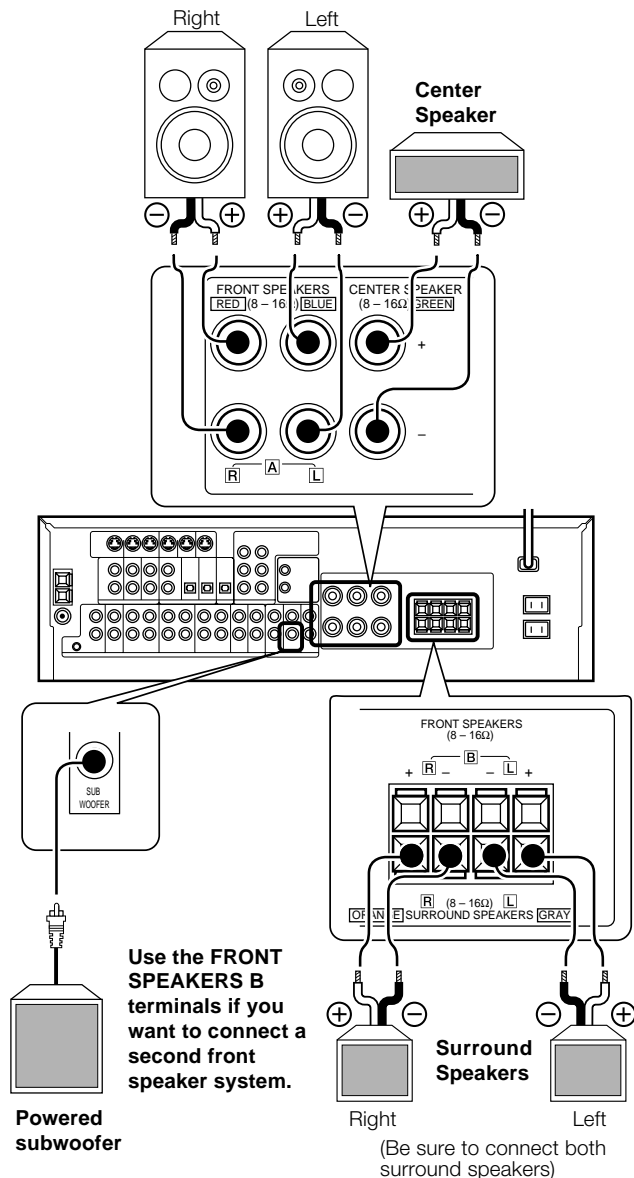

PRE OUT connections

This receiver has additional preout jacks. These can be used for various purposes, but will need to be connected to an external power amplifier as shown in the example below.

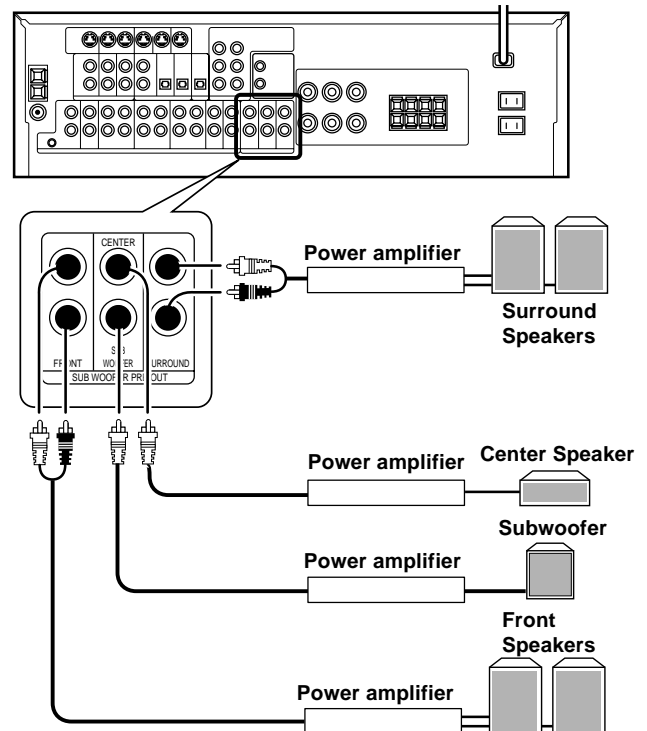

- Connecting a speaker cord directly to a PRE OUT jack will not produce any sound from the speaker.
- To use the PRE OUT jacks, press only the SPEAKERS A key to the on position.

Speaker placement

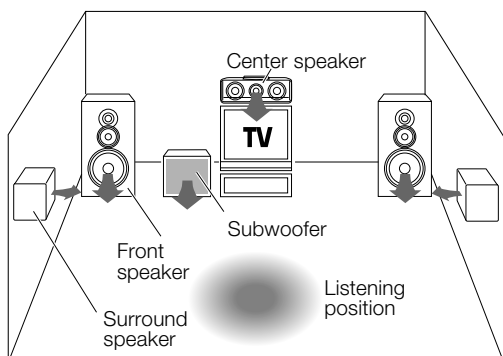

- Front speakers** : Place to the front left and right of the listening position. Front speakers are required for all surround modes.
- Center speaker** : Place front and center. This speaker stabilizes the sound image and helps recreate sound motion. Be sure to connect a center speaker when using the Dolby 3 Stereo mode.
- Surround speakers** : Place to the direct left and right, or slightly behind, the listening position at even heights, approximately 1 meter above the ears of the listeners. These speakers recreate sound motion and atmosphere. Required for surround playback.
- Subwoofer** : Reproduces powerful deep bass sounds.

• Although the ideal surround system consists of all the speakers listed above, if you don't have a center speaker or a subwoofer, you can divide those signals between the available speakers in the speaker settings steps to obtain the best possible surround reproduction from the speakers you have available. - 14

Channel space switching
(Except for the USA, Canada, UK, Europe, and Australia)

The space between radio channels has been set to the one that prevails in the area to which the system is shipped. However, if the current channel space setting does not match the setting in the area where the system is to be used, for instance when you move from area 1 or area 2 shown in the following table or vice versa, proper reception of AM/FM broadcasts cannot be expected. In this case, change the channel space setting in accordance with your area by referring to the following table.

Area	CHANNEL Space Frequency
1 USA, Canada and South American countries	FM: 100 kHz AM: 10 kHz
2 Other countries	FM: 50 kHz AM: 9 kHz

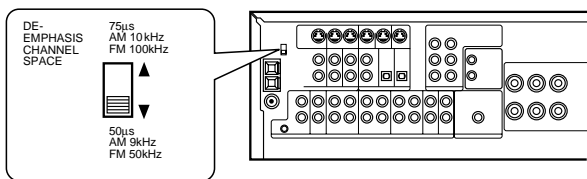

Move switch lever to match your area with a small screwdriver or other pointed tool.

Preparing the remote control

Loading the batteries

- 1 Remove the cover.
- 2 Insert the batteries.

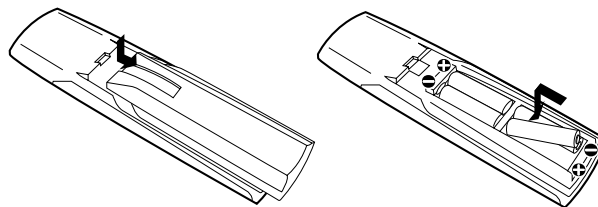

- 3 Close the cover.

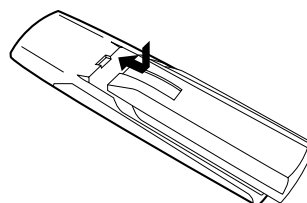

• Insert four R6/AA-size alkaline batteries as indicated by the polarity markings.

Operation

When the **STANDBY** indicator is lit, the power turns ON when you press the **SYS.POWER** key on the remote control. When the power comes ON, press the key you want to operate.

Operating range (Approx.)

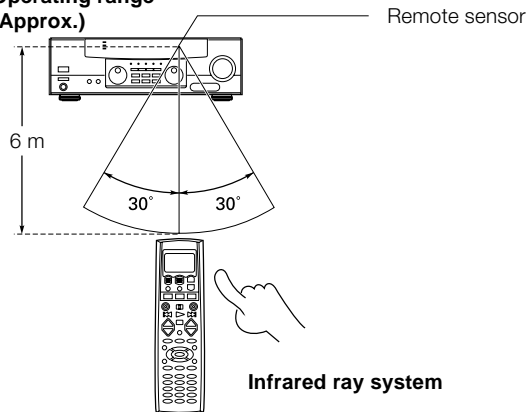

- When pressing more than one remote control key successively, press the keys securely by leaving an interval of 1 second or more between keys.

Notes

1. The supplied batteries may have shorter lives than ordinary batteries due to use during operation checks.
2. When the remote-controllable distance gets shorter than before, replace all batteries with new ones.
3. Placing the remote sensor in direct sunlight, or in direct light from a high frequency fluorescent lamp may cause a malfunction. In such a case, change the location of the system installation to prevent malfunction.

Preparing for surround sound

Speaker settings

To enable you to obtain optimum enjoyment from the receiver's listening modes, make sure to complete the speaker settings (subwoofer, front, center, and surround speakers) as described below.

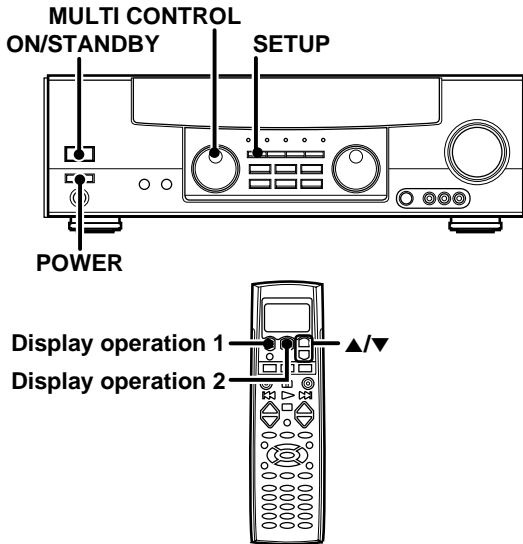

1 Turn on the power to this receiver by pressing **POWER** (and **ON/STANDBY**) key(s).

2 Select a speaker system.

1 Press the **SETUP** key to make the subwoofer setting indication (**SUBW**) appear.



When you operate on the remote control unit

1 Press the **display operation 2 [Menu]** key repeatedly until "01. IR" appears in the display of the remote control unit.

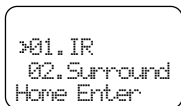

2 Press the **▲/▼** keys to select "02. Surround", then press the **display operation 2 [Enter]** key.

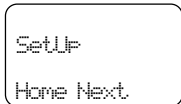

(SUBW) appears in the display of the unit.

2 Use the **MULTI CONTROL** knob or the **▲/▼** keys to select the appropriate subwoofer setting.

- **1 SUBW YES:** A subwoofer is connected to the receiver.
- **2 SUBW NO:** No subwoofer is connected to the receiver.

• When the setting "SUBW NO" is selected, the front speakers automatically are set to "Large" and the procedure skips to step **5**.

3 Press the **SET UP** or **display operation 2 [Next]** key to accept the setting.

- The front speakers setting indication (**FRNT**) appears.



4 Use the **MULTI CONTROL** knob or the **▲/▼** keys to select the appropriate front speakers setting.

- **1 FRNT NML** (normal): Average size front speakers are connected to the receiver.
- **2 FRNT LRG** (large): Large front speakers are connected to the receiver.

5 Press the **SET UP** or **display operation 2 [Next]** key to accept the setting.

- The center speaker setting indication (**CNTR**) appears.

6 Use the **MULTI CONTROL** knob or the **▲/▼** keys to select the appropriate center speaker setting.

If you selected "LRG" as the front speakers setting.

- **1 CNTR NML** (normal): An average size center speaker is connected to the receiver.
- **2 CNTR LRG** (large): A large center speaker is connected to the receiver.
- **3 CNTR NO:** No center speaker is connected to the receiver.

If you selected "NML" as the front speakers setting.

- **1 CNTR YES:** A center speaker is connected to the receiver.
- **2 CNTR NO:** No center speaker is connected to the receiver.

7 Press the **SET UP** or **display operation 2 [Next]** key to accept the setting.

- The surround speaker setting indication (**SURR**) appears.

8 Use the **MULTI CONTROL** knob or the **▲/▼** keys to select the appropriate surround speaker setting.

If you selected "LRG" as the center speaker setting.

- **1 SURR NML** (normal): Average size surround speakers are connected to the receiver.
- **2 SURR LRG** (large): Large surround speakers are connected to the receiver.
- **3 SURR NO:** No surround speakers are connected to the receiver.

If you selected other than "LRG" as the center speaker setting.

- **1 SURR YES:** Surround speakers are connected to the receiver.
- **2 SURR NO:** No surround speakers are connected to the receiver.

9 Press the **SET UP** or **display operation 2 [Next]** key to accept the setting.

- The receiver enters the speaker volume level adjustment mode.
- In steps **3** and **4**, indications appear only for the selected channels of the speakers that require adjusting.

3 Adjust the volume levels for the speakers.

Sit in your normal listening position and listen to the test tone. Adjust the volume levels for the speakers until all speakers seem to be equally loud.

- 1 Use the **MULTI CONTROL** knob or the **▲/▼** keys to adjust the volume when the test tone is being output from the speaker channel to be adjusted.

The channel indication blinks while the test tone is being output.



The test tone issues from the speakers for 2 seconds at a time in the following sequence:

Lch → Cch → Rch → RS → LS → SW → Lch

- If you change the volume level settings for the speakers while listening to music, the settings referred to on this page are also changed. → [24]
- If the speaker setting selects are changed, the speaker level settings are reset.

- 2 Press the **SET UP** or display operation 2 [Next] key.

- The receiver enters the mode for inputting the distance to the speakers.

4 Input the distance to the speakers.

- 1 Measure the distance from the listening position to each of the speakers.

Jot down the distance to each of the speakers.

Distance to front speakers: _____ feet (meters)
 Distance to center speaker: _____ feet (meters)
 Distance to surround speakers: _____ feet (meters)

- 2 Use the **MULTI CONTROL** knob or the **▲/▼** keys to select the distance to the front speakers.

The speaker indicator to be adjusted blinks.



Indication in feet Indication in meters

- The allowable setting range is 1 to 30 feet (0.3 to 9.0 m), adjustable in 1 foot (0.3 m) increments.

- 3 Press the **SET UP** or display operation 2 [Next] key.

- 4 Repeat steps 2 and 3 to input the distance for each of the speakers.

- 5 Setup is complete when the input indication reappears.



Display when all speakers have been selected.

- The speakers you selected appear on the display. Confirm that all the speakers have been correctly selected.

Input level adjustment (analog sources only)

If the input level of an analog source signal is too high, adjust the input level.

- 1 Use the **INPUT SELECTOR** knob to select the source whose input level you want to adjust.

- You can store a separate input level for each input source. If the **MONITOR** function is on, you can store an input level for when **MONITOR** is on independently of the input levels for the input sources.

- 2 Press the **SOUND** key several times until the "INPUT" indication appears.

- 3 Use the **MULTI CONTROL** knob or the **▲/▼** keys to adjust the input level.



- The adjustment mode is displayed for approximately eight seconds.
- The input level may be adjusted to any one of three settings: 0, -3, and -6. (The initial setting is 0.)

- 4 Press the **SOUND** key to return to the input indication.

Normal playback

Preparing for playback

Some preparatory steps are needed before starting playback.

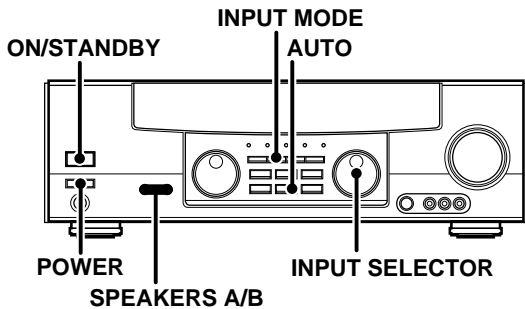

Selecting the input mode

If you have selected a component connected to the **CD, DVD, VIDEO2,** or **VIDEO3** jacks, make sure that the input mode setting is correct for the type of audio signal to be used.

Selecting MD/TAPE

Select the source name corresponding to the component connected to the MD/TAPE jacks. The initial factory setting is "TAPE". To change the source name associated with the MD/TAPE jacks to "MD," follow the steps below:

- 1 Use the **INPUT SELECTOR** knob to select "MD/TAPE".
- 2 Hold down the **AUTO** key for more than 2 seconds.
 - The source indication changes to "MD".
 - To return to the original indication, repeat the above procedure.

Selecting the speaker system

Press the **SPEAKERS A** or **B** key to select the speaker system to be used.

- A ON** : Sound from the speakers connected to the **SPEAKERS A** terminals on the rear panel.
- B ON** : Sound from the speakers connected to the **SPEAKERS B** terminals on the rear panel.
- A+B ON** : Sound from both the speakers connected to the **SPEAKERS A** and **B** terminals on the rear panel.
- A+B OFF** : No sound from the speakers. Use this setting when listening with headphones for stereo sound and virtual surround in all playback modes.

The indicator for the speakers you want to use should be lit.

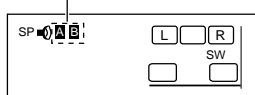

- Activating a surround mode or selecting "DVD 6ch" as the input source causes speaker system A to be selected automatically.
- When you use the **PRE OUT** jacks, press the only **SPEAKERS A** key to the on position.

Turning on the receiver

- 1 Turn on the power to the related components.
- 2 Turn on the power to this receiver by pressing **POWER** or **SYS.POWER** $\frac{1}{\phi}$ (and **ON/STANDBY**) key(s).

Listening to a source component

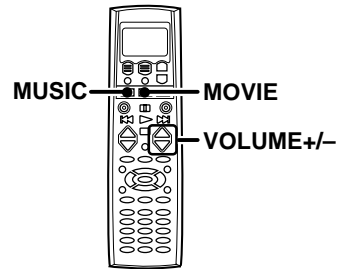
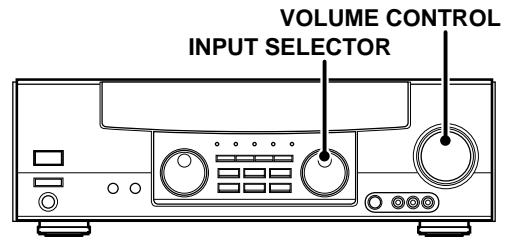

- 1 Use the **INPUT SELECTOR** knob, **MUSIC** key, or **MOVIE** key to select the source you want to listen to.

The input sources change as shown below:

Selecting a source using the **INPUT SELECTOR** knob

- 1 "PHONO"
- 2 "TUNER"
- 3 "CD/DVD"
- 4 "TAPE" or "MD"
- 5 "VIDEO1"
- 6 "VIDEO2"
- 7 "VIDEO3"
- 8 "DVD/6ch"
- 9 "AV AUX"

Selecting a source using the **MUSIC** key

- 1 "CD/DVD"
- 2 "TAPE" or "MD"
- 3 "TUNER"
- 4 "PHONO"

Selecting a source using the **MOVIE** key

- 1 "VIDEO1"
- 2 "VIDEO2"
- 3 "VIDEO3"
- 4 "DVD/6ch"
- 5 "AV AUX"

- 2 Start playback from the selected source.

- 3 Use the **VOLUME CONTROL (VOLUME +/-)** to adjust the volume.

Adjusting the sound

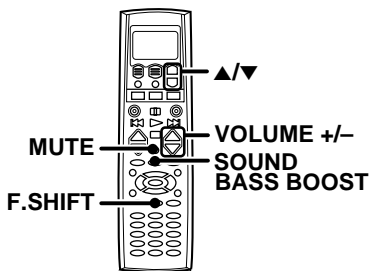
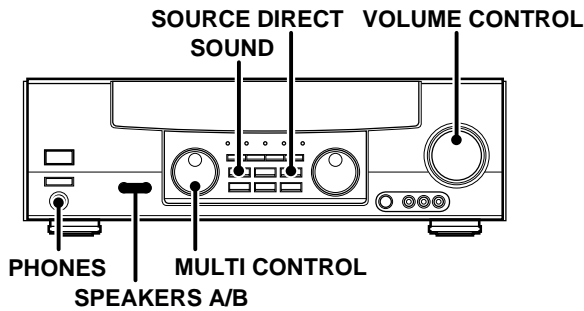

Adjusting the tone

You can adjust the sound quality when the receiver is in the stereo mode.

➊ Press the **SOUND** key to select the tone mode to be adjusted.

- BASS:** Select this to adjust the low frequency range. (Press the **SOUND** key once.)
- TREB:** Select this to adjust the high frequency range. (Press the **SOUND** key twice.)

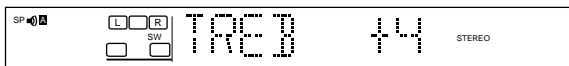

➋ Use the **MULTI CONTROL** knob or the **▲/▼** keys to adjust the sound quality.

- The bass and treble levels are adjustable from -10 to +10 in 2 step increments.
- The adjustment item is displayed for approximately 8 seconds.

Once-touch low frequency emphasis (bass boost)

You can adjust the sound quality when the receiver is in the stereo mode.

Press the **F.SHIFT** key, then press **BASS BOOST** key.

- Press the key once to select the maximum (+10) low frequency emphasis setting.
- This key does not function when the receiver is in the sound quality or ambience effects adjustment mode.

Switching back to the previous setting

Press the **BASS BOOST** key again.

Muting the sound

The MUTE key lets you mute the sound of the speakers.

Press the **MUTE** key.

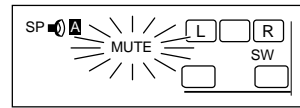

Blinks

To cancel

Press the **MUTE** key again so that the "MUTE" indicator goes off.

- Muting can also be canceled by adjusting the volume.

SOURCE DIRECT playback (analog sources only)

Use this function to pass the source material direct to the amplifier, bypassing any audio processing.

Press the **SOURCE DIRECT** key.

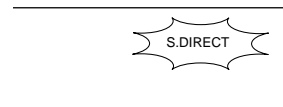

- When you press the **LISTEN MODE**, **SOUND**, or **SETUP** keys, or switch to another input source, SOURCE DIRECT playback will be canceled.

To cancel

Press the **SOURCE DIRECT** key again.

- If SOURCE DIRECT playback was activated when using a surround mode, cancelling it reactivates the previous surround mode.

Listening with headphones

➊ Press the **SPEAKERS A** or **B** key so that the speaker indicator goes off.

Make sure the Speaker indicator are turned off.

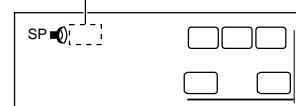

- If you turn off all of the speakers when in the surround mode, the mode is cancelled as well, resulting in stereo playback.
- The speakers do not switch off during the 6CH INPUT mode. Select the other input mode.

➋ Connect headphones to the **PHONES** jack.

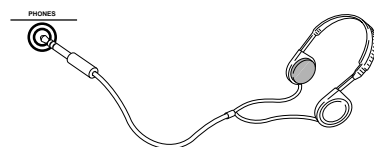

➌ Use the **VOLUME CONTROL (VOLUME +/-)** to adjust the volume.

Recording audio (analog sources)

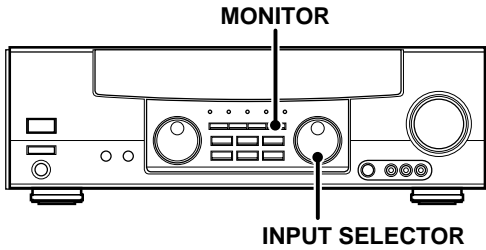

Recording a music source

- 1 Use the **INPUT SELECTOR** knob to select the source (other than "MD/TAPE") you want to record.
- 2 Set the cassette deck or MD recorder to record.
- 3 Start playback, then start recording.

Recording tapes or MDs

MONITOR → MD/TAPE recording

- 1 Press the **MONITOR** key. 
- 2 Use the **INPUT SELECTOR** knob to select a source other than "MD/TAPE."
- 3 Start playback on the cassette deck connected to the **MONITOR** jacks and start recording on the cassette deck connected to the **MD/TAPE** jacks.

MD/TAPE → MONITOR recording

- 1 Use the **INPUT SELECTOR** knob to select "MD/TAPE."
- 2 Start playback on the cassette deck connected to the **MD/TAPE** jacks and start recording on the cassette deck connected to the **MONITOR** jacks.
 - To copy tapes using a double cassette deck, refer to the instruction manual of the double cassette deck.

MONITOR function (analog sources only)

You can connect a cassette deck or graphic equalizer to the **MONITOR** jacks of the receiver. If a graphic equalizer is connected, the **MONITOR** key should be left in the on position. Alternately, if a cassette deck equipped with a 3-head system is connected to the **MONITOR** jacks, you will be able to monitor the just-recorded signal while making recordings on the cassette deck. By switching the **MONITOR** key on and off, you can compare the sound of the source signal and the just-recorded signal. For more information, refer to the instruction manual of the connected component.

Recording video

- 1 Use the **INPUT SELECTOR** to select the video source (other than "VIDEO1") you want to record.
- 2 Set the video deck connected to **VIDEO 1** to record.
 - Select the **REC MODE** to record a digital input source.
- 3 Start playback, then start recording.
 - With certain video software, recording may not be normal due to the copy guard condition. → 26

Recording audio (digital sources)

Switch on the **REC MODE** to record a digital input source. Usually use the **A-REC MODE** to record audio input sources. When the digital mode changes during recording in the **A-REC MODE**, the audio may be interrupted momentarily. To record the audio from the beginning of the digital mode change, use the **M-REC MODE**.

Recording music in A-REC MODE

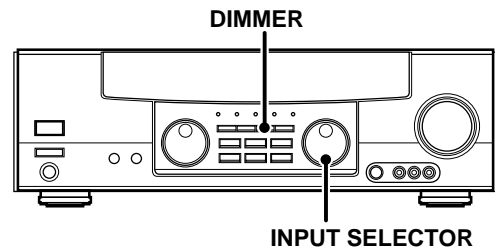

- 1 Use the **INPUT SELECTOR** to select the source (CD, DVD, VIDEO2, or VIDEO3) you want to record.
- 2 Set the cassette deck or MD recorder to record.
- 3 Press and hold the **DIMMER** key for more than 2 seconds to select the **A-REC MODE**.
 - The mode changes every 2 seconds as shown below.

- | | |
|--|---|
| <ol style="list-style-type: none"> 1 REC MODE off : 2 A-REC MODE : 3 M-REC MODE : | <p>The digital input record mode is switched off.</p> <p>The digital input signals (DTS, Dolby Digital, or PCM) are identified automatically and converted into stereo signals that are ready for recording.</p> <p>The input signal type at the moment this mode is selected is held throughout this mode.</p> |
|--|---|

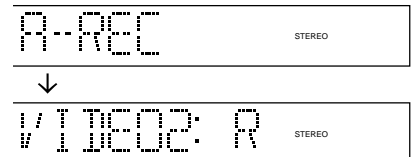

- 4 Start playback, then start recording.
 - If the audio reproduction stops in the middle due to change in the input signals, etc., press the **DIMMER** key.

Recording music in M-REC MODE

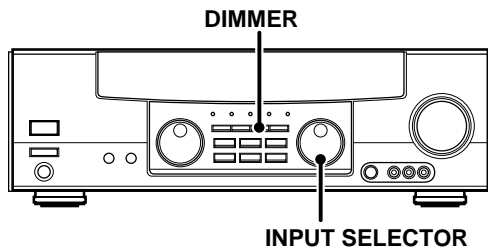

- 1 Use the input selector to select the source (CD, DVD, VIDEO2, or VIDEO3) you want to record.
- 2 Set the cassette deck to record.
- 3 Play the source to be recorded.
- 4 Press and hold the DIMMER key for more than 2 seconds to select the M-REC MODE.

• The mode changes every 2 seconds as shown below.

- | | |
|---|--|
| <p>1 REC MODE off :</p> <p>2 A-REC MODE :</p> <p>3 M-REC MODE :</p> | <p>The digital input record mode is switched off.</p> <p>The digital input signals (DTS, Dolby Digital or PCM) are identified automatically and converted into stereo signals that are ready for recording.</p> <p>The input signal type at the moment this mode is selected is held throughout this mode.</p> |
|---|--|

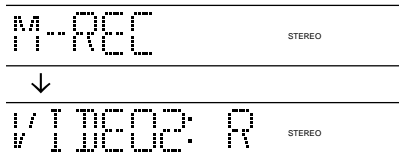

- 5 Play the source from the beginning and start recording.

• If the audio reproduction stops in the middle due to change in the input signals, etc., press the DIMMER key.

Tuning radio stations

The receiver can store up to 40 stations in the memory and recall them by one-touch operation.

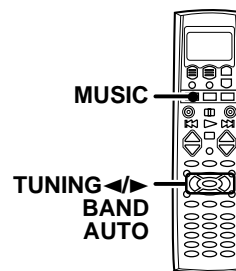
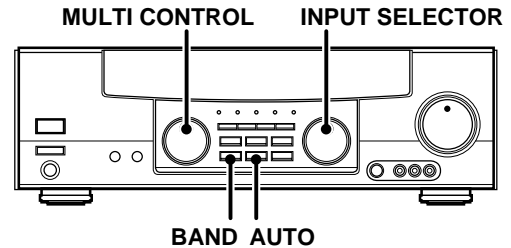

- 1 Use the INPUT SELECTOR knob or MUSIC key to select the tuner.

- 2 Use the BAND key to select the desired broadcast band.

Each press switches the band as follows:

- 1 FM
- 2 AM

"AM" or "FM" indicator

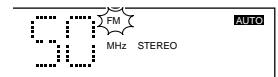

- 3 Use the AUTO key to select the desired tuning method.

Each press switches the tuning method as follows:

- 1 AUTO lit (auto tuning)
- 2 AUTO not lit (manual tuning)

"AUTO" indicator lights.

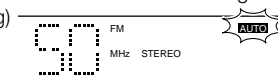

• Normally, set to "AUTO" (auto tuning). If the radio waves are weak and there is a lot of interference, switch to manual tuning. (With manual tuning, stereo broadcasts will be received in monaural.)

- 4 Use the MULTI CONTROL knob (◀▶ key) to select the station.

Frequency display Lights when a broadcast is being received in stereo.

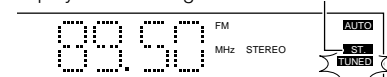

"TUNED" is displayed when a station is received

Auto tuning : The next station is tuned automatically.
Manual tuning : Turn the knob (press the key) to select the desired station.

Presetting radio stations manually

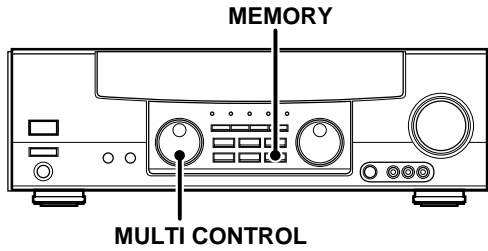

- 1** Tune to the station you want to store.
- 2** Press the **MEMORY** key while receiving the station.

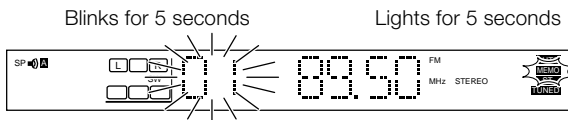

Proceed to step **3** within 5 seconds.
(If more than 5 seconds elapse, press the **MEMORY** key again).

- 3** Use the **MULTI CONTROL** to select one of the station presets (1 – 40).
- 4** Press the **MEMORY** key to accept the setting.
 - Repeat steps **1**, **2**, **3**, and **4** to store as many stations as necessary.
 - If you store a station at a previously used preset, the old station will be replaced by the new one.

Receiving preset stations

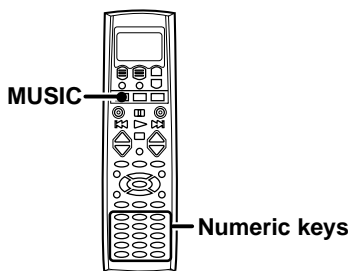

- 1** Press the **MUSIC** key to select the tuner as the source.
- 2** Enter the number of the preset you want to receive (up to "40").

Press the numeric keys in the following order:

For "15", press **+10**, **5**
 For "20", press **+10**, **+10**, **0**

- If you make a mistake entering a two digit number, press the **+10** key several times to return to the original display and start again.

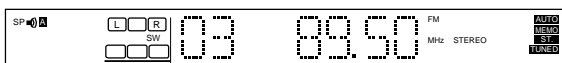

Receiving preset stations in order (P.CALL)

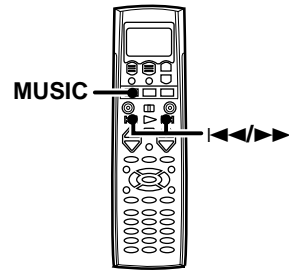

- 1** Use the **MUSIC** key to select the tuner as the source.
- 2** Use the **◀◀/▶▶** keys to select the desired station.

- Each time you press the key, another preset station is received in order.

Pressing the **▶▶** key does the following:

01→02→03→ 38→39→40→01→02→03→

Pressing the **◀◀** key does the following:

01←02←03← 38←39←40←01←02←03←

- Holding down the key, lets you skip through the presets, receiving each for 0.5 seconds apiece.

Ambience effects

This receiver is equipped with listening modes that allow you to enjoy an enhanced sonic ambience with a variety of video sources.

In order to obtain the optimum effect from the surround modes, make sure to input the proper speaker settings beforehand.

- 14

Surround modes

DTS

The DTS multi-channel audio format is available on CD, LD and DVD software. DTS is a strictly digital format and can not be decoded inside most CD, LD or DVD players. For this reason, if you attempt to listen to DTS encoded software through the analog output of your new CD, LD or DVD player, you will experience digital noise in most cases. This noise can be quite loud if the analog output is connected directly to a high power amplification system. Proper measures for playing the digital output as described below should be taken to avoid this situation. To enjoy DTS Digital Surround playback, an external 5.1 channel DTS Digital Surround decoder system or an amplifier with a built-in DTS Digital Surround decoder must be connected to the digital output (S/P DIF, AES/EBU or TosLink) of a CD, LD or DVD player.

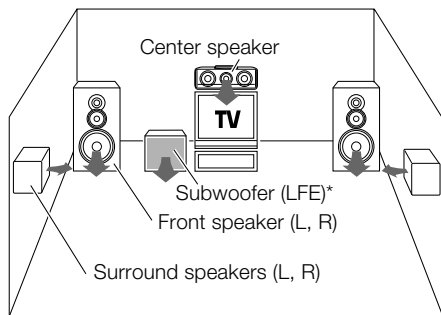

* Optional in this mode.

* LFE = Low Frequency Effects. This channel delivers separate non-directional bass signals to the subwoofer for more dynamic deep bass sound effects.

DTS has a .1 or LFE channel.

The indication "**LFE**" appears in the display when a signal is being input for this channel.

Manufactured under license from Dolby Laboratories. "Dolby", "Pro Logic" and the double-D symbol are trademarks of Dolby Laboratories. Confidential Unpublished Works. ©1992-1997 Dolby Laboratories. All rights reserved.

Manufactured under license from Digital Theater Systems, Inc. US Pat. No. 5,451,942 and other worldwide patents issued and pending.

"DTS" and "DTS Digital Surround" are trademarks of Digital Theater Systems, Inc.

© 1996 Digital Theater Systems, Inc. All rights reserved.



"Circle Surround and the **CS** symbol are trademarks of SRS Labs, Inc. in the United States and selected foreign countries. Circle Surround technology is incorporated under license from SRS Labs, Inc".

Dolby Digital (AC-3)

The Dolby Digital (AC-3) surround format lets you enjoy up to 5.1 channels of digital surround sound from Dolby Digital (AC-3) program sources (such as Laserdisc or DVD software marked **DOLBY DIGITAL**). Compared with previous Dolby surround, Dolby Digital (AC-3) provides even better sound quality, greater spatial accuracy, and improved dynamic range.

Note

Although a full set of speakers (front left, right, and center, surround left and right, and a subwoofer) is required for true 5.1 channel Dolby Digital (AC-3) surround sound, this receiver lets you enjoy Dolby Digital (AC-3) (and Dolby Surround) program sources, even if you connect only the front speakers. ("Speaker placement")

- 13

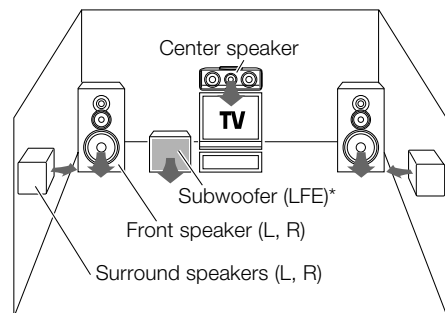

* LFE = Low Frequency Effects. This channel delivers separate non-directional bass signals to the subwoofer for more dynamic deep bass sound effects.

Although only Dolby Digital (AC-3) soundtracks incorporate a separate low frequency channel, connecting a subwoofer will also improve deep bass performance in the other surround modes.

The indication "**LFE**" appears in the display when a signal is being input for this channel.

Dolby Pro Logic

Dolby Pro Logic is a specially encoded 2 channel surround format designed to provide theater-like surround sound from Dolby Surround encoded sources (such as video and Laserdisc software marked **DOLBY SURROUND**). This receiver is equipped with a Dolby Pro Logic surround decoder to let you enjoy the wide variety of currently available Dolby Surround home video software.

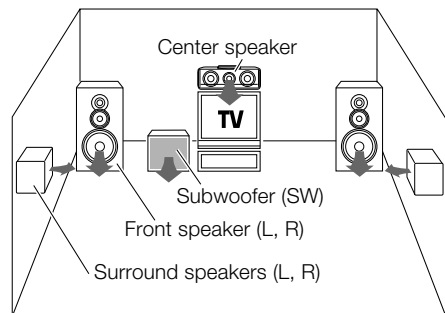

Continued to next page

Dolby 3 Stereo

Dolby 3 Stereo is available for systems that do not have surround speakers. When in the Dolby 3 Stereo mode, the surround information is redirected to the front left and right speakers. This mode is designed for use with Dolby Surround program sources, but can also improve sound field unity for programs that are not Dolby Surround encoded. Dialog positioning and sound image definition, however, may not be as accurate when used with programs that are not Dolby Surround encoded.

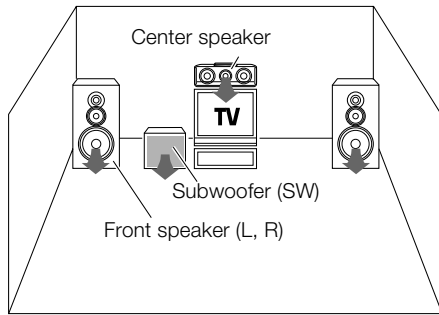

Multi channel music (SRS Circle Surround)

SRS Circle surround enables you to listen to multi channel sound from the stereo source. We assume you have already enjoyed listening to Dolby digital sound/DTS multi channel sound with your multi speakers. Now, this time try listening to the stereo source (ex. Audio CD) using your multi speakers. You may discover a new type of "stereo" sound through SRS Circle Surround.

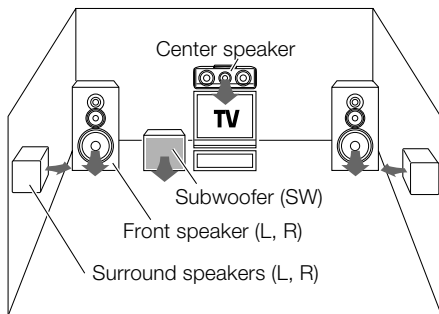

DSP mode

The DSP mode lets you add the atmosphere of a live concert or hall to almost any type of program source. These modes are particularly effective when used with stereo program sources, like CD, television, and FM radio. You might enjoy trying the ARENA or THEATER mode the next time you watch a concert or sporting event!

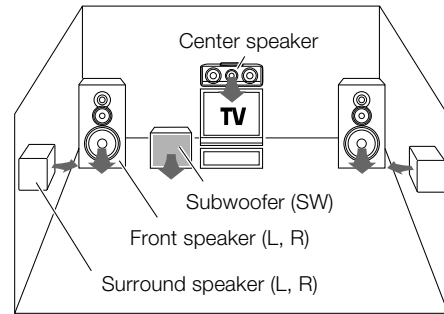

What's DSP?

DSP stands for Digital Signal Processor. The way a sound is heard in an actual environment depends on a variety of different factors. One of the most important is reverberation (the act of decaying elements of sound echoing in various places). The DSP modes produce the feeling of presence by using the DSP to create reverberation, without spoiling the sound quality of the original signal.

DVD 6-channel mode

Using a DVD player or the like equipped with six (5.1) output channels and the receiver, you can enjoy multi-channel encoded DVD source material in all its splendor. Since the source signals are digital and each channel is input independently, the resulting sound quality, sense of spaciousness, and dynamic range are superb.

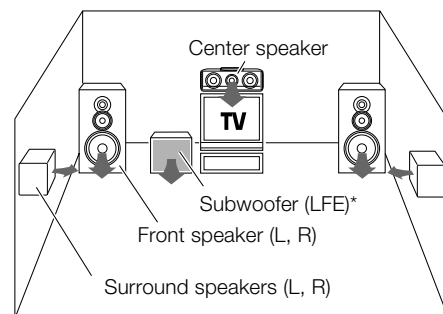

* LFE = Low Frequency Effects. This channel delivers separate non-directional bass signals to the subwoofer for more dynamic deep bass sound effects.

The indication "LFE" appears in the display when a signal is being input for this channel.

Surround Play

The DTS compatible models can reproduce a CD, DVD, or LD carrying the DTS mark.

DOLBY DIGITAL can be used when playing DVD or LD software bearing the **DOLBY DIGITAL** mark and DOLBY DIGITAL (AC-3) format digital broadcasts (etc.). DOLBY PRO LOGIC and DOLBY 3 STEREO can be used when playing video, DVD, or LD software bearing the **DOLBY SURROUND** mark. SRS Circle surround enables you to listen to multi channel sound from the stereo source.

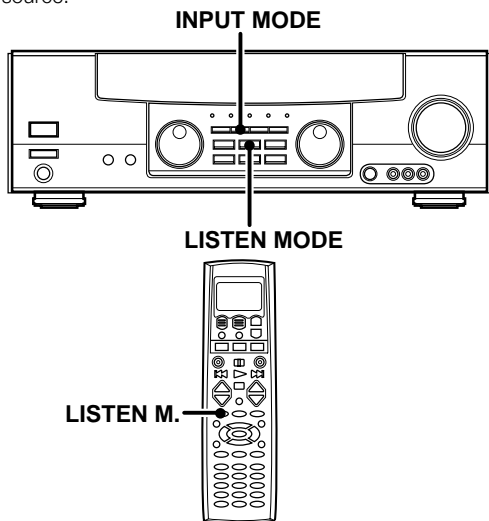

Preparations

- Turn ON related components.
- Complete "Preparing for surround sound" (speaker settings). → [14]
- Use the **INPUT SELECTOR** knob to select the component you wish to play back with surround sound.
- Use the **INPUT MODE** key to select the input mode (analog or digital) for the source you wish to play back. → [9]
- Noise will be produced when a DTS source is played by selecting the analog input.

1 Start playing the video software.

2 Press the LISTEN MODE (LISTEN M.) key to select the listening mode.

The listening mode settings are stored separately for each input. If the input mode is set to digital auto ("AUTO SOUND" lights), the receiver selects the optimal listening mode automatically based on the type of input signal and the speaker settings.

Each press of the LISTEN MODE (LISTEN M.) key switches the setting as listed below.

The listening mode settings are different depending on the type of input signal.

When the DOLBY DIGITAL signal is input:

(The DOLBY DIGITAL, PROLOGIC, or 3 STEREO indicator lights up.)

- ① **DOLBY DIGITAL**: DOLBY DIGITAL surround
- ② **PRO LOGIC**: PRO LOGIC surround
- ③ **3 STEREO**: 3-STEREO surround
- ④ **CIRCLE SURROUND**: CS 5.1 surround
- ⑤ **STEREO**: Normal stereo playback

When you select DOLBY DIGITAL



When the DTS signal is input:

(The DTS indicator lights up.)

- ① **DTS**: DTS surround
- ② **STEREO**: Normal stereo playback

When the analog signal or the digital signal except for the DOLBY DIGITAL or DTS signal is input:

- ① **PRO LOGIC**: PRO LOGIC surround (The PRO LOGIC indicator lights up.)
- ② **3 STEREO**: 3-STEREO surround (The 3-STEREO indicator lights up.)
- ③ **CIRCLE SURROUND**: CS 5.1 surround (The CS 5.1 indicator lights up.)
- ④ **ARENA**: DSP surround
- ⑤ **JAZZ CLUB**: DSP surround
- ⑥ **THEATER**: DSP surround
- ⑦ **STEREO**: Normal stereo playback

- If a Dolby Digital signal having more channels than the maximum number of playback channels available using the receiver's current settings is input, the **DOWN MIX** indicator in the display lights up and downmixing is performed to match the number of available channels.

3 Adjust the volume.

Notes

- Depending on the type of the signal or speaker setting, some listening modes cannot be selected.
- When playback is started, the sound may be cut or interrupted before the input source is confirmed as Dolby Digital.
- To enjoy Dolby Digital (AC-3) surround (as well as all the other listening modes) from a single component, be sure to use a Dolby Digital (AC-3) compatible source component. Connect the Dolby Digital (AC-3) compatible source component's Dolby Digital (AC-3) format digital audio signal to one of the **DIGITAL INPUT** jacks on the back of the receiver. Connect the normal audio signal correctly to the respective component's **AUDIO** jacks. → [7] → [8] → [9] → [10]

DVD 6-channel playback

Using a DVD player or the like equipped with six (5.1) output channels and the receiver, you can enjoy surround sound playback. When you try to play a disc other than Dolby Digital (AC-3) such as DTS CD, no sound is produced or, noise may be heard. To avoid this situation, make sure that you connect the component to the receiver's DVD 6CH. INPUT jacks through a surround processor which can decode the surround signal you want to listen to. Connecting a DVD player which can decode the surround signal itself is also acceptable.

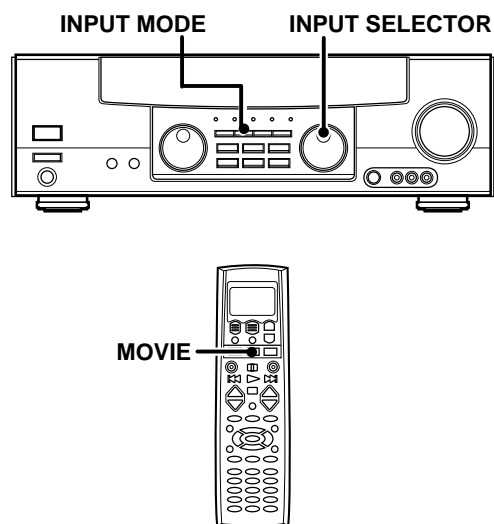

Preparations

- Connect your DVD player to the DVD 6ch jacks of the receiver. → 8
- Turn on all other components that will be used. → 14
- Complete "Preparing for surround sound". → 14

1 Select "DVD/6ch" as the input source.

- If speaker system B is on when "DVD/6ch" is selected as the input source, it switches off and speaker system A turns on automatically.

2 Select "6CH INPT" by pressing the INPUT MODE key.

3 Start playback of the DVD software.

4 Adjust the volume.

- It is not possible individually to adjust the volume level or sound quality (SETUP, SOUND) of the separate channels when the receiver is in the DVD 6ch mode. Adjust the volume with the controls of the DVD player. For the powered subwoofer, you can adjust the volume of the subwoofer using the subwoofer's own volume control.

Convenient functions

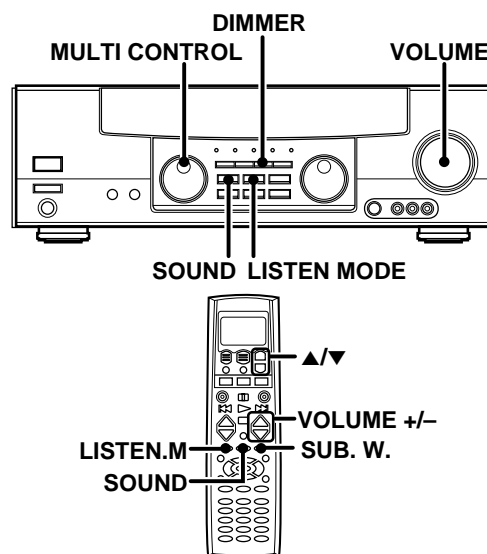

Adjusting the sound

You can make further adjustments to the sound while listening to playback in the surround mode.

- 1 Press the **SOUND** key to select the item you want to adjust.

Each press switches the selection as listed below.
Note that some items are not displayed in certain modes.

- | | | |
|---|---|------|
| 1 | BASS (low frequency range sound quality adjustment) | → 17 |
| 2 | TREB (high frequency range sound quality adjustment) | → 17 |
| 3 | Cch (center speaker level adjustment) | |
| 4 | RS (right surround speaker level adjustment) | |
| 5 | LS (left surround speaker level adjustment) | |
| 6 | SW (subwoofer level adjustment) | |
| 7 | INPUT (input level adjustment) | → 15 |
| 8 | NIGHT (midnight mode on/off) | → 25 |
| 9 | CINEMA/MUSIC (select the circle surround mode) | → 25 |

- 2 Use the **MULTI CONTROL** knob or the **▲/▼** keys to adjust the setting as desired.

- The adjustment item is displayed for approximately 8 seconds.

Midnight mode (Dolby Digital (AC-3) mode only)

When watching movies at night you might not be able to raise the volume as loud as normal. Midnight mode compresses the dynamic range of previously specified parts of the Dolby Digital (AC-3) sound track (like scenes with sudden increases in volume) to minimize the difference in volume between the specified and non-specified parts. This makes it easy to hear all of the sound track, even when listening at low volumes.

- 1 Press the **SOUND** key several times until "NIGHT" is displayed.
 - This can be selected only if **CD/DVD**, **VIDEO2**, or **VIDEO3** is selected as the source and the input mode is set to "DOLBY DIGITAL."
- 2 Use the **MULTI CONTROL** knob or the **▲/▼** keys to select the on or off setting.



- The adjustment item is displayed for approximately 8 seconds.
- Some Dolby Digital (AC-3) software may not be compatible with the Midnight mode.

Circle surround mode

When you enjoy multi sound from the stereo source (Circle Surround), you can select the circle surround mode.

- 1 Press the **LISTEN MODE (LISTEN M.)** key so that "CIRCLE SURROUND" is displayed.
- 2 Press the **SOUND** key so that "CINEMA/MUSIC" is displayed.
- 3 Use the **MULTI CONTROL** knob or the **▲/▼** keys to select "CINEMA" (for movies) or "MUSIC" (for music).

SUBWOOFER adjustment

It is easy to adjust the volume of the subwoofer using the remote control.

- 1 Press the **SUB. W.** key so that "SW" is displayed.



- 2 Use the **VOLUME (VOLUME+/-)** to adjust the volume.
 - The adjustable range is -10 dB to +10 dB.

Display dimmer adjustment

The dimmer function lets you select the brightness of the receiver's display. You might find this useful if you darken your room to watch movies or listen to music.

Each time you press the DIMMER key, the display brightness changes among the three available settings. Select the brightness level you find most pleasing.

When you operate on the remote control unit, press the F.SHIFT key before pressing the DIMMER key.

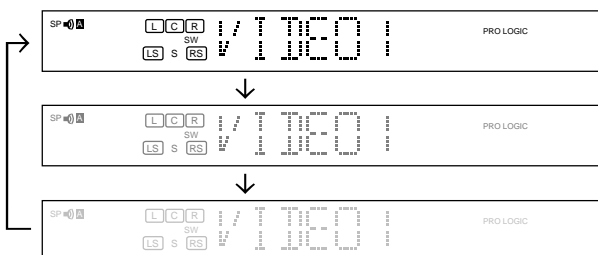

96KHz LPCM playback

The receiver is compatible with the 96kHz LPCM playback. To play a 96kHz DVD, set the listen mode to "STEREO."

- When "96kHz" appears in the display, press the **LISTEN MODE** key (the listen mode changes to the STEREO mode).

Resetting the Microcomputer

If the microcomputer may malfunction (unit cannot be operated, or shows an erroneous display) if the power cord is unplugged while the power is ON, or due to some other external factor. If this happens, execute the following procedure to reset the microcomputer and return the unit to its normal operating condition.

- Please note that resetting the microcomputer will clear the contents of the memory and returns the unit to the state it was in when it left the factory.

For U.S.A. and Canada

Unplug the power cord from the wall outlet, then plug it back in while holding down the POWER key.

For other countries

With the power cord plugged in, turn the POWER key OFF. Then, while holding down the ON/STANDBY key, press POWER.

Amplifier

Symptom	Cause	Remedy
No sound from the speakers.	<ul style="list-style-type: none"> • The speaker cords are disconnected. • VOLUME is set to the minimum position. • MUTE is ON. • The SPEAKERS switches are set to OFF. 	<ul style="list-style-type: none"> • Connect them properly referring to "Connecting the speakers" - 12 • Adjust the volume to a proper level. • Turn OFF the MUTE. - 17 • Set the SPEAKERS switch(es) to ON. - 16
The standby indicator blinks and sound is not output.	<ul style="list-style-type: none"> • Speaker cords are short-circuited. 	<ul style="list-style-type: none"> • Turn the power off, eliminate the short-circuiting, then turn on the power again.
Sound is not output from one of the speakers.	<ul style="list-style-type: none"> • The speaker cord is disconnected. 	<ul style="list-style-type: none"> • Connect it properly referring to "Connecting the speakers". - 12
Sound is not output from the surround speakers and / or the center speaker, or their sound is very small.	<ul style="list-style-type: none"> • The surround speaker cords and/or the center speaker cord is disconnected. • A surround mode has not been engaged. • The surround and/or center volume controls are set to the minimum level. 	<ul style="list-style-type: none"> • Connect it properly referring to "Connecting the speakers". • Select a surround mode. • Adjust the speaker levels using the test tone. - 15
A humming noise is generated when the PHONO input selector is selected.	<ul style="list-style-type: none"> • The audio cord from the turntable is not connected to the PHONO jacks. • The turntable is not grounded. 	<ul style="list-style-type: none"> • Insert the audio cord plugs securely into the PHONO jacks. • Connect the grounding wire to the GND terminal on the rear panel.
When playing a Dolby Digital (AC-3) source signal using a DVD player, the sound is cut off soon after it starts.	<ul style="list-style-type: none"> • There are many possible causes for this problem, depending on the type of DVD player used. 	<ul style="list-style-type: none"> • Set the input mode to digital manual before starting playback of the Dolby Digital source. - 9
No sound is produced during playback from a DVD player.	<ul style="list-style-type: none"> • The input mode is set to digital manual. 	<ul style="list-style-type: none"> • Press the INPUT MODE key to select to digital auto mode. - 9
A video source cannot be recorded normally.	<ul style="list-style-type: none"> • The software is copy-guarded. 	<ul style="list-style-type: none"> • Copy-guarded video software cannot be recorded.

Tuner

Symptom	Cause	Remedy
Radio stations cannot be received.	<ul style="list-style-type: none"> • No antenna is connected. • The broadcast band is not set properly. • The frequency of the desired station is not tuned. 	<ul style="list-style-type: none"> • Connect an antenna. - 10 • Set the broadcast band properly. • Tune the frequency of the desired station. - 19
Interference.	<ul style="list-style-type: none"> • Noise due to ignition noise from an automobile. • Noise due to interference from an electric appliance. • Noise due to a nearby TV set. 	<ul style="list-style-type: none"> • Install the outdoor antenna away from the road. • Turn off the power to the appliance. • Install the receiver farther away from the TV.
A station which was preset cannot be received by pressing the corresponding numeric key.	<ul style="list-style-type: none"> • The preset station belongs to a frequency that cannot be received. • The preset memory was cleared because the power cord had been unplugged for a long period of time. 	<ul style="list-style-type: none"> • Preset a station with a receivable frequency. • Preset the station again.

For U.S.A and Canada (VR-409)

AUDIO section

Rated power output during STEREO operation

100 watts per channel minimum RMS, both channels driven, at 8 Ω from 20 Hz to 20 kHz with no more than 0.7% total harmonic distortion. (FTC)

Effective power output during SURROUND operation

FRONT (20-20kHz, 0.7% T.H.D. at 8 Ω, one channel driven)	100 W + 100 W
CENTER (20-20kHz, 0.7% T.H.D. at 8 Ω, one channel driven)	100 W
SURROUND (20-20kHz, 0.7% T.H.D. at 8 Ω, one channel driven)	100 W + 100 W
Total harmonic distortion	0.055% (1 kHz, 50W, 8 Ω)
Frequency response	CD 10 Hz ~ 53 kHz, +0 dB, -3.0 dB
Signal to noise ratio (IHF'66)	
PHONO (MM)	75 dB
CD	91 dB
Input sensitivity / impedance	
PHONO (MM)	2.5 mV / 27 kΩ
CD	200 mV / 47 kΩ
Output level / impedance	
TAPE REC	200 mV / 1 kΩ
PRE OUT (SUBWOOFER)	2 V / 2.2 kΩ
Tone control	
BASS	±10 dB (at 100 Hz)
TREBLE	±10 dB (at 10 kHz)

DIGITAL AUDIO section

Sampling frequency	32 kHz, 44.1 kHz, 48 kHz, 96kHz
Input level / impedance / wave length	
Optical	(-15 dBm ~ -21 dBm), 660 nm ±30nm
Coaxial	0.5 Vp-p / 75 Ω

VIDEO section

VIDEO inputs / outputs

VIDEO (composite)	1 Vp-p / 75 Ω
S VIDEO (luminance signal)	1 Vp-p / 75 Ω
(chrominance signal)	0.286 Vp-p / 75 Ω

FM tuner section

Tuning frequency range	87.5 MHz ~ 108 MHz
Usable sensitivity (MONO)	1.6 μV (75 Ω) / 15.2 dBf (75 kHz DEV., SINAD 30 dB)
50dB quieting sensitivity	
STEREO	31.6 μV (75 Ω) / 41.2 dBf
Total harmonic distortion (1 kHz)	
MONO	0.6% (65 dBf input)
STEREO	0.7% (65 dBf input)
Signal to noise ratio (1 kHz, 75 kHz DEV.)	
MONO	75 dB (65 dBf input)
STEREO	68 dB (65 dBf input)
Stereo separation (1 kHz)	38 dB
Selectivity (±400 kHz)	70 dB
Frequency response	(30 Hz ~ 15kHz), +0.5 dB, -3.0 dB

AM tuner section

Tuning frequency range	
10 kHz step	530 kHz ~ 1,700 kHz
Usable sensitivity (30% mod., S/N 20 dB)	16 μV / (600 μV/m)
Signal to noise ratio (30% mod. 1 mV input)	50 dB

GENERAL

Power consumption	2.6 A
AC outlet	
SWITCHED	(total 150 W, 1.25 A max.)
Dimensions	W : 440 mm (17-5/16")
	H : 143 mm (5-5/8")
	D : 400 mm (15-3/4")
Weight (Net)	7.4 kg (15.8 lb)

Notes

1. KENWOOD follows a policy of continuous advancements in development. For this reason specifications may be changed without notice.
2. The full performance may not be exhibited in an extremely cold location (under a water-freezing temperature).

For other countries (KRF-V8030D)

AUDIO section

Effective power output during STEREO operation
 1kHz,10% T.H.D.,at 8 Ω 140 W + 140 W
 Rated power output during STEREO operation

100 watts per channel minimum RMS, both channels driven, at 8 Ω from 20 Hz to 20 kHz with no more than 0.7% total harmonic distortion.(FTC)

Effective power output during SURROUND operation
 FRONT (1kHz, 10% T.H.D. at 8 Ω, one channel driven)
 140 W + 140 W
 CENTER (1kHz, 10% T.H.D. at 8 Ω, one channel driven)
 140 W
 SURROUND (1kHz, 10% T.H.D. at 8 Ω, one channel driven)
 140 W
 Total harmonic distortion 0.055% (1 kHz, 50W, 8 Ω)
 Frequency response
 CD 10 Hz ~ 53 kHz, +0 dB, -3.0 dB
 Signal to noise ratio (IHF'66)
 PHONO (MM) 75 dB
 CD 91 dB
 Input sensitivity / impedance
 PHONO (MM) 2.5 mV / 27 kΩ
 CD 200 mV / 47 kΩ
 Output level / impedance
 TAPE REC 200 mV / 1 kΩ
 PRE OUT (SUBWOOFER) 2 V / 2.2 kΩ
 Tone control
 BASS (For Australia and U.S-Military) ±10 dB (at 100 Hz)
 BASS (Other countries) ±10 dB (at 60 Hz)
 TREBLE ±10 dB (at 10 kHz)

DIGITAL AUDIO section

Sampling frequency 32 kHz, 44.1 kHz, 48 kHz, 96kHz
 Input level / impedance / wave length
 Optical (-15 dBm ~ -21 dBm), 660 nm ±30nm
 Coaxial 0.5 Vp-p / 75 Ω

VIDEO section

VIDEO inputs / outputs
 VIDEO (composite) 1 Vp-p / 75 Ω
 S VIDEO (luminance signal) 1 Vp-p / 75 Ω
 (chrominance signal) 0.286 Vp-p / 75 Ω

FM tuner section

Tuning frequency range 87.5 MHz ~ 108 MHz
 Usable sensitivity (MONO)
 1.6 μV (75 Ω)/ 15.2 dBf (75 kHz DEV., SINAD 30 dB)
 50dB quieting sensitivity
 STEREO 31.6 μV (75 Ω)/ 41.2 dBf
 Total harmonic distortion (1 kHz)
 MONO 0.6% (65 dBf input)
 STEREO 0.7% (65 dBf input)
 Signal to noise ratio (1 kHz, 75 kHz DEV.)
 MONO 75 dB (65 dBf input)
 STEREO 68 dB (65 dBf input)
 Stereo separation (1 kHz) 38 dB
 Selectivity (±400 kHz) 50 dB
 Frequency response (30 Hz ~ 15kHz), +0.5 dB, -3.0 dB

AM tuner section

Tuning frequency range
 9 kHz step 531 kHz ~ 1,602 kHz
 10 kHz step 530 kHz ~ 1,610 kHz
 Usable sensitivity (30% mod., S/N 20 dB)
 16 μV / (600 μV/m)
 Signal to noise ratio (30% mod. 1 mV input) 50 dB

GENERAL

Power consumption 250 W
 AC outlet
 SWITCHED (total 90 W max.)
 Dimensions W : 440 mm
 H : 143 mm
 D : 400 mm
 Weight (Net) 7,4 kg

Notes

1. KENWOOD follows a policy of continuous advancements in development. For this reason specifications may be changed without notice.
2. The full performance may not be exhibited in an extremely cold location (under a water-freezing temperature).

Remote Control Instruction Manual

Preset Remote Control Quick Start Guide

Quick start guide	29
Getting the most from your remote control	31
Remote operation of other components	39
In case of difficulty	42

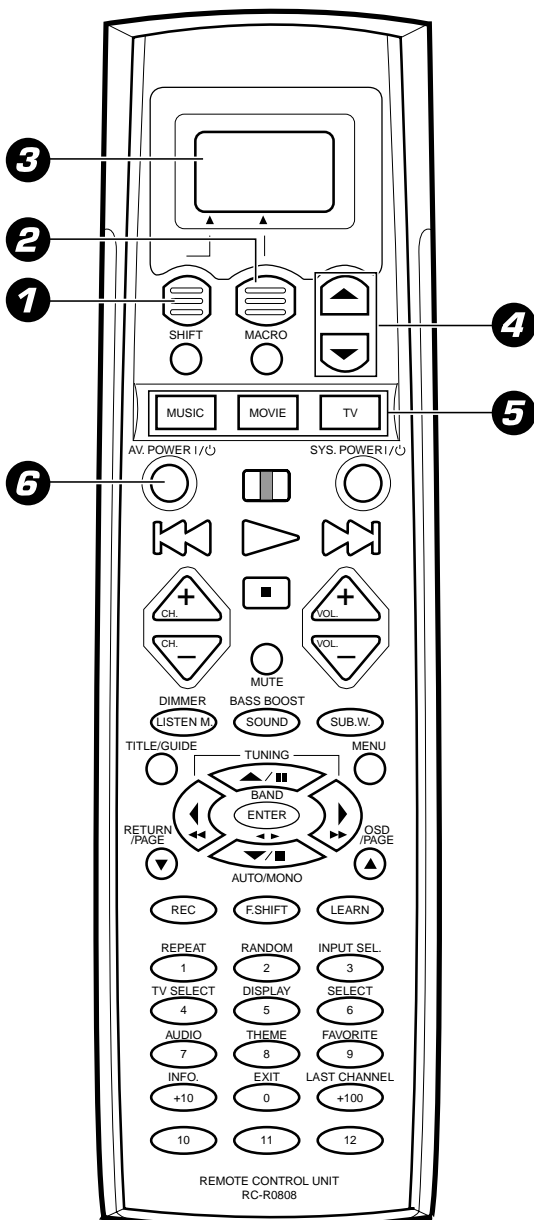

This quick start guide explains how to setup the remote control to operate audio and video components other than the receiver.

In order to make full use of the functions of the remote control, be sure to read the section of this manual entitled "Getting the most from your remote control". It contains a detailed explanation of how to operate the remote control and make the necessary settings. The quick start guide describes the operation of the following keys:

- 1 Display operation 1 key**
Use this key to go back to the previous display or initial display.
- 2 Display operation 2 key**
Gets you into and out of the preset code registration mode.
- 3 Display**
The information for setup is displayed.
- 4 ▲/▼ keys**
Use these keys to select the source or setup code.
- 5 MOVIE, MUSIC, and TV keys**
Use these keys to select the input you want to register.
- 6 AV.POWER I/O key**
Once you have entered the setup code for another component, you can press this key to turn power to that component on or off. This lets you confirm that you entered the code properly.

Register the setup codes for your audio and video components

Step 1

Video1:
VCR
Menu

Press the **display operation 1** key repeatedly until "Menu" appears in the display.



For step 1 through step 9, make sure you start the next step within 8 seconds of completing the previous one. If more than 8 seconds elapses between any two steps, press the display operation key so that the display appears.

Step 2

*01. IR
02. Surround
Home Enter

Press the **display operation 2 [Menu]** key repeatedly until "01. IR" appears in the display.

Step 3

*01. IR
02. Surround
Back Enter

Press the **▲/▼** keys to select "01. IR", then press the **display operation 2 [Enter]** key.

Step 4

*03. Video1
04. Video2
Back Enter

Press the **▲/▼** keys to select the input that you want to register, then press the **display operation 2 [Enter]** key.

Step 5

*05. VCR
06. Cable
Back Enter

Press the **▲/▼** keys to select the component that you want to register, then press the **display operation 2 [Enter]** key.

Step 6

*Kenwood
Aiwa
Back Enter

Press the **▲/▼** keys to select the maker of the component that you want to register, then press the **display operation 2 [Enter]** key.

Step 7

*01: 0056
02: Nothing
Back Enter

Press the **▲/▼** keys to select the setup code.

Step 8

AV.POWER I/O



Press the **AV.POWER I/O** key to see if you can turn the component on and off.

If your component has a mechanical POWER switch that cannot be operated by remote control unit, press the **display operation 2 [Enter]** key and **display operation 1 [Home]** key, and select the component by pressing the **MUSIC**, **MOVIE**, or **TV** key, then press the **PLAY (▷)** key or **TUNING (◀▶)** key to test it.

If the component does not respond when you try to control it, return to step 7 and enter the next setup code on the list. Repeat this procedure until you find the code that matches the component. When the component does not respond, select "Nothing."

Step 9

*01. IR
02. Surround
Home Enter

Press the **display operation 2 [Enter]** key to store the code.

Repeat steps 3 through 9 to enter the codes for each component you want to control.

Press the **display operation 1** key repeatedly until "Menu" appears in the display.

If you accidentally exit the registration mode by pressing the wrong key, you will not lose any setup codes you have already saved.

Automatic input naming

In the initial factory setting, the remote control already has provisional component names registered for each input. Before you register setup codes, pressing the input keys of the remote control causes the display to change from the factory preset input names of the receiver (VIDEO1, VIDEO2, etc.) to the input names registered in the remote control (VCR1, VCR2, etc.). Once you have registered the appropriate setup codes for your components, pressing the input keys of the remote control causes the display to change to the actually connected component names (LD, DVD, etc.) for which you have registered setup codes.

Getting the most from your remote control

The remote control supplied with this receiver is also capable of controlling components from a variety of manufacturers once you register the appropriate setup codes into the remote control unit.

Refer to "Remote operation of other components" for details about the operations available for each component.



Low battery warning

Replace all four batteries with new ones when you notice a shortening of the distance from which the remote control will operate. The remote control is designed to retain setup codes in memory while you change batteries.

How to use the display operation keys

To register the setup code, use the **display operation 1** key, **display operation 2** key, or **▲/▼** keys.

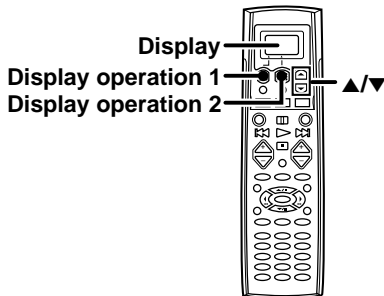

The **display operation 1** key and **display operation 2** key work as the function key displayed in the display above.

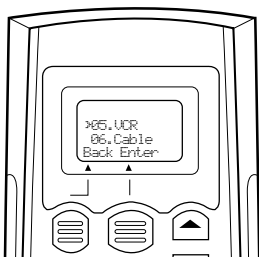

The display operation 1 key

- **[Back]**
Go back to the previous display.
- **[Home]**
Go back to the initial display.
- **[Clr]**
Erase the internal memory.

The display operation 2 key

- **[Enter]**
Enter the selected item.
- **[Menu]**
Display the menu.
- **[Setup]**
Go to the setup display.
- **[Exit]**
Exit from the current operation.
- **[Sel]**
Select the item.

When the display goes off

The display goes off automatically when you do not operate for more than 8 seconds. In this case, press the **display operation 1** key, **display operation 2** key, or **▲/▼** keys.

When you are confused about what's being displayed

Press the **display operation 1** key repeatedly until "Menu" appears in the display. The display returns to the initial display.

Registering setup codes for other components

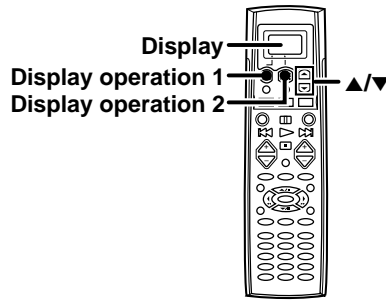

- 1** Press the **display operation 1** key repeatedly until "Menu" appears in the display.

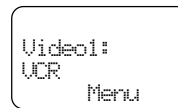

For step **1** through step **2**, make sure you start the next step within 8 seconds of completing the previous one. If more than 8 seconds elapses between any two steps, press the display operation keys so that the display appears.

- 2** Press the **display operation 2 [Menu]** key repeatedly until "01. IR" appears in the display.

- The setup display appears.

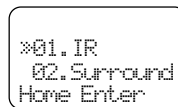

- 3** Press the **▲/▼** keys to select "01. IR," then press the **display operation 2 [Enter]** key.

- The input selecting display appears.

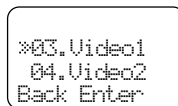

- At this time all inputs become available regardless of any earlier registration.

- 4** Press the **▲/▼** keys to select the input that you want to register.

- Each time you press the **▲/▼** key, the input changes as follows:

- ▶ 01: CD/DVD
- 02: MD/Tape
- 03: Video1
- 04: Video2
- 05: Video3
- 06: DVD
- 07: TV1
- 08: TV2
- 09: Cable
- ▶ 10: Phono

- Example: To select the source connected the VIDEO1 jack, select "Video1".

5 Press the display operation 2 [Enter] key.

- The source selecting display appears.
- When you select "Phono" in step 4, go to step 10.

```
*05.VCR
 06.Cable
Back Enter
```

6 Press the ▲/▼ keys to select the source you want to register.

- Each time you press the ▲/▼ key, the input changes as follows:

```
▶ 01: CD
 02: Tape
 03: MD
 04: CD-R
 05: VCR
 06: Cable
 07: Satellit
 08: TV
 09: LD
 10: DVD
 11: DSS (U.S.A only)
 12: No type
▶ 13: Delete
```

- Select "No type" when the desired source does not appear in the display.
- The selected input does not appear when you select "Delete."

7 Press the display operation 2 [Enter] key.

- The maker selecting display appears.

For Europe and U.K

```
*Kenwood
Aiwa
Back Enter
```

For other countries

```
*Kenwood
Admiral
Back Enter
```

8 Press the ▲/▼ keys to select the maker you want to register.

- Press the ▲/▼ keys until the desired maker appears in the display. When the desired maker does not appear, select "Nothing."

9 Press the display operation 2 [Enter] key.

- The setup code selecting display appears.

```
*01:0056
 02:Nothing
Back Enter
```

10 Press the ▲/▼ keys to select the setup code.**11** Press the AV.POWER I/O key, and check to see that the component you want to control turns on.

If the component does not react, and there is more than one setup code, enter another setup code and try again.

- ▷ or TUNING key can also be used instead of the AV. POWER I/O key.
- If the component is already on, pressing the AV. POWER I/O key will turn it off.

12 Press the display operation 2 [Enter] key.

- The display returns to the setup display.

```
*01.IR
 02.Surround
Home Enter
```

Repeat steps 5 to 12 to register additional components until all components have been registered.

To return to the initial display, press [Back] repeatedly until "Menu" appears in the display.

```
Videol:
VCR
Menu
```

- Once registered, the display on the receiver shows the component type instead of the default input name. Example: if you register a VCR at the VIDEO 1 jacks, "Videol" and "VCR" appear in the display.
- Any VIDEO or TV (TV1, TV2, CABLE) inputs that have not been programmed with a setup code or Non-IR code are deleted from the cyclic list.

When you mistake

Press the display operation 1 [Back] key repeatedly until the display you want to re-operate appears.

Note

Although each setup code is designed to work with a number of different models, certain codes may not work with some models. (Also, certain codes may only operate some of the functions available on a given model.)

Operating other components

This operation lets you operate the registered components. KENWOOD audio components with system control turn on and off automatically with the receiver via the system control connections.

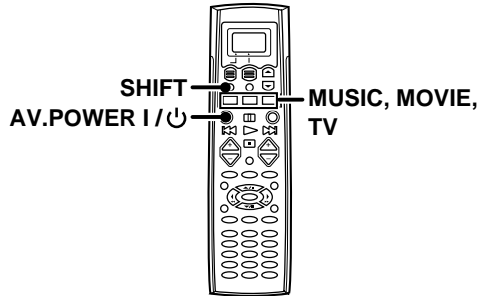

During operation, make sure you start the next step within 8 seconds of completing the previous one. If more than 8 seconds elapses between any two steps, press the display operation key so that the display appears.

1 Use the MUSIC, MOVIE, or TV key to select the component you desire.

- Pressing the **MUSIC** or **MOVIE** key also changes the input selector on the receiver. If you do not want to change the current input, press the **SHIFT** key before step 2.

MUSIC key

- 1 CD/DVD
- 2 TAPE or MD
- 3 Tuner
- 4 PHONO

MOVIE key

- 1 Video1
- 2 Video2
- 3 Video3
- 4 DVD 6CH
- 5 AV AUX

TV key

- 1 TV1
- 2 TV2
- 3 CABLE

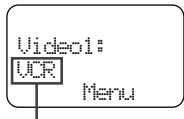

Select source

- You cannot select the source that is not registered.

2 Press the AV. POWER I/O key.

- The selected component turns on or off.

3 Press the operation keys you desire.

- See "Remote operation of other components" at the end of this manual for a list of keys available with each component.

RC-11

The remote control mode remains in the set at the component selected in step 1 mode until you select another component.

Note

Be sure to point the remote control at the remote sensor on the receiver when you want to operate KENWOOD components connected by system control cords. Otherwise, point the remote control at the component you want to operate.

Changing (confirming) the operation mode

This operation lets you change the remote control operation mode without changing the input selector.

You may find this useful when you want to control one component while using another. (For example, if you want to rewind the tape deck while listening to a CD.)

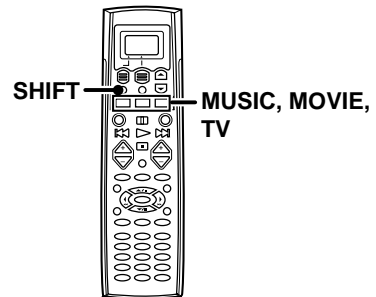

During operation, make sure you start the next step within 8 seconds of completing the previous one. If more than 8 seconds elapses between any two steps, press the display operation key so that the display appears.

1 Press the SHIFT key.

- "Shift" appears in the display.

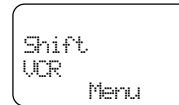

- To operate a TV, start from step 2.

2 Press the MUSIC, MOVIE, or TV key repeatedly to display the remote control mode for the component you want to control.

Press the **MUSIC**, **MOVIE**, or **TV** key until the desired source appears.

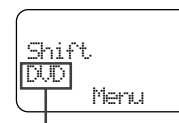

The component to be controlled

- Pressing any other keys after the **SHIFT** key cancels the shift function and sends the normal code associated with the respective key.
- The input selector does not change during this operation.
- If you press **MUSIC** or **MOVIE** key more than 3 seconds after pressing the **SHIFT** key, the input selector changes together with the operation mode.

3 Execute the desired operations.

- See "Remote operation of other components" for a list of keys available with each component.

RC-11

The operation mode remains set at the component specified in step 2.

To return control to the original component, press **SHIFT** and then press the **MUSIC** or **MOVIE** key to return to the original control mode.

Preparing for automatic operations (MACRO play)

The macro play function allows you to set the remote to control several components in succession. After completing this setup, you can perform a series of operations automatically. Enter the setup codes for the components you want to control beforehand.

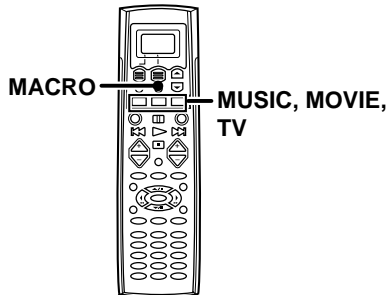

During operation, make sure you start the next step within 8 seconds of completing the previous one. If more than 8 seconds elapses between any two steps, the remote control unit exits from the MACRO play mode.

1 Make a plan of the macro play you want to Setup.

The order of the operations may be fairly complex and you may not be remember all of the necessary commands during the setup procedure.

Use the space provided below to write down the operations in the order you are going to enter them.

- Up to 20 steps can be memorized for each macro.

1		11	
2		12	
3		13	
4		14	
5		15	
6		16	
7		17	
8		18	
9		19	
10		20	

- The example below shows the plan for step 4 (which occupies a total of 6 steps) :

① TV + AV. POWER	2 steps
② FUNCTION SHIFT + 3	2 steps
③ MOVIE	1 steps
④ AV. POWER	1 steps
Total	6 steps

- If you attempt to store more than 20 steps, "Full" appears and exit the macro programming mode.
- Enter channel numbers (for the monitor TV, etc.) exactly as you would using the original remote.
- When you select the input by using the **MUSIC**, **MOVIE**, or **TV** key, it is count 1 step even if you press these keys several times.

2 Press and hold the MACRO key for more than 2 seconds.

- "MACRO MEMORY" appears in the display.

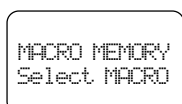

3 Press the MUSIC, MOVIE, or TV key to select the macro location. (MACRO1, 2, and 3 respectively)

- You can store up to 3 different macros, one at each key: **MOVIE** → "MACRO 1", **MUSIC** → "MACRO 2", **TV** → "MACRO 3"
- The light flashes once when you select the macro location.
- Pressing a key other than **MUSIC**, **MOVIE**, or **TV** cancels the macro program mode.

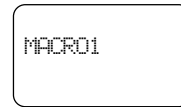

When **MOVIE** is pressed

4 Press the keys to be operated in order.

EXAMPLE:

This example shows you how to create a macro that; turns on the TV, sets the TV to the appropriate input, selects the receiver's input selector to LD, and turns on the LD player. All you have to do is insert the laser disc!

- 1 Press the **TV** key, then press the **AV.POWER** 1/⊕ key to turn on the TV.
- 2 Press the **F. SHIFT** key, then press the **"3" (INPUT SEL.)** key to set the TV to the appropriate video input.
- 3 Press the **MOVIE** key to select the LD player registered at VIDEO 2.
- 4 Press the **AV.POWER** 1/⊕ key to turn on the LD player.

- Make sure you start the next operation within 8 seconds of completing the previous one. If more than 8 seconds elapses between any two steps, exit the macro programming mode.
- In order to allow verification of the remote control mode, the name of the selected input appears in the receiver's display when the **MUSIC**, **MOVIE**, or **TV** key is pressed. When the **MUSIC** or **MOVIE** key is pressed the receiver's input also changes.

5 Press the MACRO key so that the light flashes twice.

- The macro is stored at the locations specified in step 3. If another macro was previously stored at the same location, it is erased.

Repeat steps 1 through 5 to program up to 3 macros.

This completes the macro programming procedure.

Executing an automatic operation

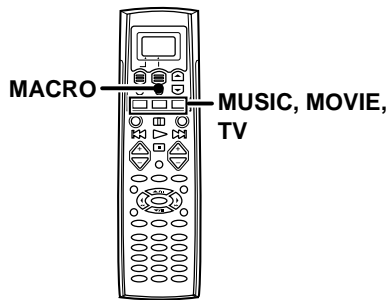

During operation, make sure you start the next step within 8 seconds of completing the previous one. If more than 8 seconds elapses between any two steps, press the display operation key so that the display appears.

1 Press the **MACRO** key.

- "MACRO EXE" appears in the display.

```
MACRO EXE
Select MACRO
```

2 Press the **MUSIC**, **MOVIE**, or **TV** key to execute the corresponding macro play.

- "MACRO EXE" appears in the display and the pre-programmed macro is performed:
MUSIC → "MACRO 1", **MOVIE** → "MACRO 2", **TV** → "MACRO 3"
- Some devices take up to 1 second to power on. The macro function has an automatic delay after any power function output.
- Pressing a key other than **MUSIC**, **MOVIE**, or **TV** cancels the macro program mode.

```
MACRO1 EXE
```

When **MUSIC** is pressed

To delete the setup code

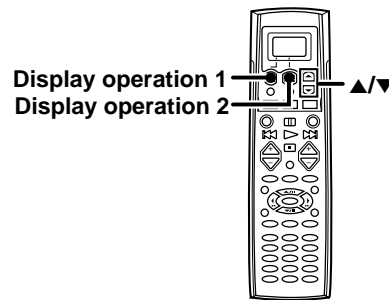

During operation, make sure you start the next step within 8 seconds of completing the previous one. If more than 8 seconds elapses between any two steps, press the display operation key so that the display appears.

1 Press the **display operation 1** key repeatedly until "Menu" appears in the display.

```
Video1:
UCR
Menu
```

2 Press the **[Menu]** key repeatedly until "01. IR" appears in the display.

- The setup display appears.

```
*01. IR
02. Surround
Home Enter
```

3 Press the **▲/▼** keys to select "01. IR," then press the **[Enter]** key.

- The input selecting display appears.

```
*03. Video1
04. Video2
Back Enter
```

4 Press the **▲/▼** keys to select the input that you want to delete, then press the **[Enter]** key.

5 Press the **▲/▼** keys to select "Delete."

```
*13:Delete
01:CD
Back Enter
```

6 Press **[Enter]**.

- The setup code is deleted.

36 Storing the remote control cord of the other components

The remote control unit can store the remote control cord of the other components and you can operate the other components from the remote control unit. The remote control cord is stored on the key or memory of the remote control unit.

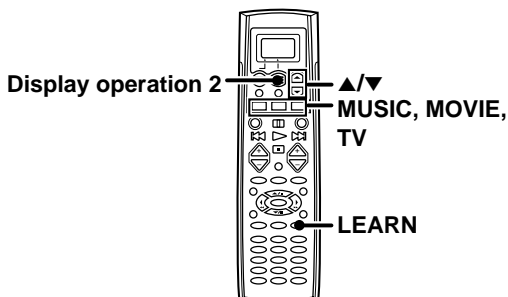

Storing on the key

You can store the remote control code to the key as shown below:

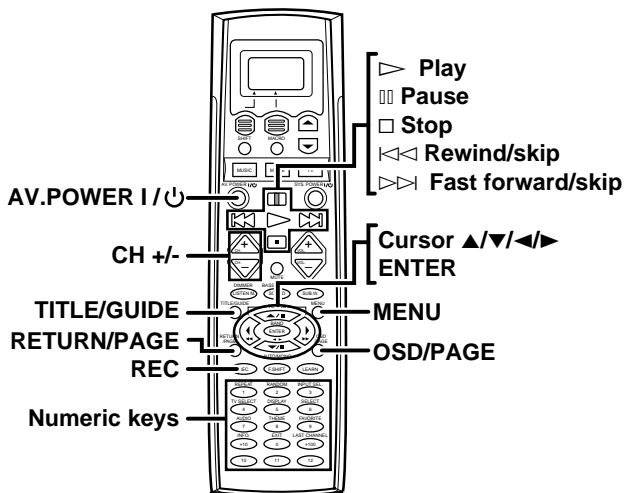

- 1 Point the infrared ray system part of another remote control unit to the remote sensor of the remote control unit .

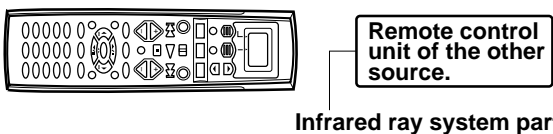

- 2 Press the MUSIC, MOVIE, or TV key to select the input of the desired remote control unit.

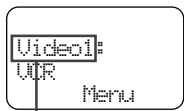

Selected input

- 3 Press the LEARN key.

When the setup code is registered

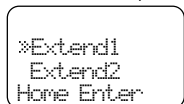

- When the setup code is not registered, any messages do not appear.

- 4 Press the desired key of the remote control unit.

- The remote control is ready for receiving the remote control code.

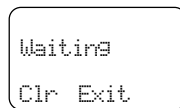

- 5 Press the key of the same operation that you want to store.

- The remote code is send to the remote control unit.
- "Complete" appears when finished.

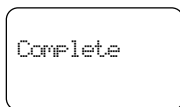

- When it takes for more than 5 seconds or the remote control unit does not receive the remote control code well, "Error" appears in the display. In this case, re-operate from the step 1.

- 6 The remote control code is stored on the key of the remote control unit.

To delete the memory stored on the key

Press the [Clr] key in step 4. "Cleared" appears in the display. The memory previously stored is cleared.

To operate other components

- 1 Press the MUSIC, MOVIE, or TV key to select desired input source.
- 2 Press the desired key.

Storing on the memory

You can store on the remote control unit up to 5 memories.

- 1 Point the infrared ray system part of the other remote control unit to the remote sensor of the remote control unit .

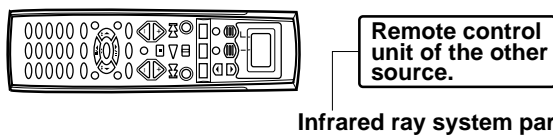

- 2 Press the MUSIC, MOVIE, or TV key to select the input of the desired remote control unit.

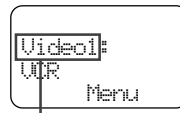

Selected input

- 3 Press the LEARN key.

- The Extend selecting display appears.

When the setup code is registered

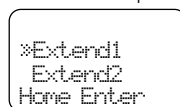

- When the setup code is not registered, any messages do not appear.

④ Press the ▲/▼ keys to select the location.

- Extend1 – Extend5 are available.

⑤ Press the [Enter] key.

- The remote control is ready for receiving the remote control code.

```
Waiting
Extend1
Clr Exit
```

⑥ Press the key of the same operation that you want to store.

- The remote code is send to the remote control unit.
- "Complete" appears when finished.

```
Complete
Extend1
```

- When it takes for more than 8 seconds or the remote control unit does not receive the remote control code well, "Error" appears in the display. In this case, re-operate from the step ①.
- "Full" appears when the memory is full. Re-operate from the step ① after deleting some memories.

⑦ The remote control code is stored on the memory (Extend1 – Extend5) of the remote control unit.

To delete the stored memory

Press the [Clr] key in step ⑤. "Cleared" appears in the display and the memory that is selected in step ④ is erased.

To operate other components by using the stored memory

① Press the MUSIC, MOVIE, or TV key to select desired input source.

- The Menu display appears.

② Press the [Menu] key .

③ Press the ▲/▼ keys to select the memory you want to operate.

④ Press the [Enter] key.

Restoring the original factory settings

You can restore the setup codes or memories to their original default settings.

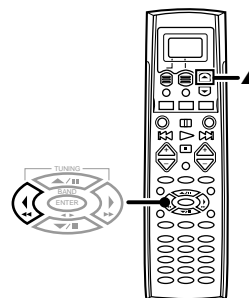

Insert the batteries during pressing and holding the [▲] keys and [◀▶] key.

- "Cleared" appears in the display, and the remote settings return to their original default settings.

Displaying the CD TEXT data

When you connect a KENWOOD CD player (CD-425M, CD-4700M, CD-4260M, DPF-J6030), you can display the CD TEXT data in the display of the remote control unit.

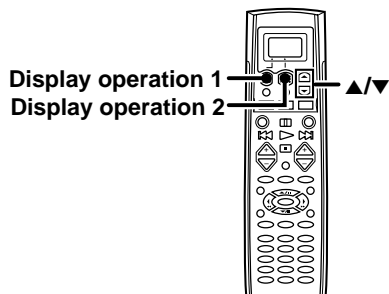

Before operation, register the setup code of the CD player.

1 Load the CD TEXT data to the CD player.

- 1 Press the MUSIC key to select "CD".
- 2 Press the [Menu] key repeatedly until "SetUp" appears in the display.
- 3 Press the ▲/▼ keys to select "All Read" and press the [Enter] key.
 - The loading time may take a few moments.

2 Load the CD TEXT data of the CD player to the remote control unit.

- 1 Press the MUSIC key to select "CD".
- 2 Press the [Menu] key repeatedly until "SetUp"s appears in the display.
- 3 Press the ▲/▼ keys to select "Disc Title" and press the [Enter] key.
 - The remote control unit starts reading the CD TEXT data (disc titles are also read).
 - ☺ appears during reading.

3 Press the [Home] key.

- "Text" appears when the CD TEXT data is read.

```

CD-TEXT
CD
Text Menu
  
```

- When "Text" does not appear, select "Track Title" in the "SetUp" display and press the [Enter] key.

4 Press the [Text] key.

- The display for selecting disc appears.

```

*050.D.Title
051.
Home Sel
  
```

5 Press the ▲/▼ keys to select the desired disc, then press the [Sel] key.

```

*01.T.Title
02.T.Title
Back Sel
  
```

6 Press the ▲/▼ keys to select the desired track, then press the [Sel] key.

Remote operation of other components

You can operate other components by pressing keys or using the display.
The setup code for each component must be entered beforehand. **RC-3**

When you operate by using the keys

- 1 Press the **MUSIC, MOVIE, or TV** key to select the component you want to control.
- 2 Press the keys corresponding to the operations you desire.

- To execute a **FUNCTION SHIFT** command written above the numeric keys, press the **F. SHIFT** key, then press the corresponding key.
- When pressing keys in succession, press each key firmly and be sure to wait at least 1 second before pressing the next key.

When you operate by using the display

- 1 Press the **MUSIC, MOVIE, or TV** key to select the component you want to control.
- 2 Press the display operation 2 [Menu] key so that the Menu display appears.
- 3 Press the **▲/▼** keys to select desired item or memory, then press the display operation 2 [Enter] key.

Notes

1. Although each setup code is designed to work with a number of different models, certain codes may not work with some models. (Also, certain codes may only operate some of the functions available on a given model.)
2. The charts below show the typical functions available for each component. Some manufacturers use different key combinations to perform similar functions.

Tuner operations

BAND
AUTO/MONO
TUNING ◀
TUNING ▶

Numeric keys

REPEAT	1	2	3
TV SELECT	4	5	6
BAND	7	8	9
MEMO	0	LAST CHANNEL	+100
+10	-10	-11	-12

Cassette deck operations

Display operation
01-05: Extend 1 - 5

ENTER (Play B)
II (Pause B)
■ (Stop B)
◀◀ (Rewind B)
▶▶ (Fast forward B)

REC (Recording)

FUNCTION SHIFT commands

▷ (Reverse play A), **ENTER** (Reverse play B)

CD player operations

Display operation
01: Disc Sel
02: Set
03: P.Mode
04: Check
05: Clear
06: Disc Title
07: Track Title
08: All Read
09: Subout Monitor
10: Continuous Play
11: All Info.
12-16: Extend1-5

REPEAT
RANDOM
DISPLAY

FUNCTION SHIFT commands

▷ (Reverse play A), **ENTER** (Reverse play B)

MD recorder operations





Display operation
01-05: Extend1-5

REC (Recording)



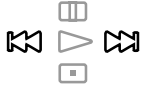





FUNCTION SHIFT commands

▷ (Reverse play A), **ENTER** (Reverse play B)







TV operations

 CHANNEL + CHANNEL -  VOLUME + ▽ ▽ ▽ VOLUME - ▽ ▽ ▽	 Cursor ▲/▼/▶/◀ ENTER  (Mute)	 Numeric keys	 FUNCTION SHIFT commands INPUT SEL. TV SELECT AUDIO	<p>Display operation</p> <p>01: -/-- 02: >12 03: Wide 04: Picture in Picture 05: Text/Mix/TV 06: Text Off 07: Mix 08: Exit 09-13: Extend1-5</p>
--	--	--	--	---



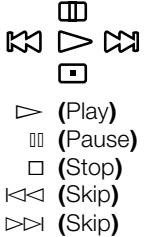



VCR operations

 CHANNEL + CHANNEL -  Cursor ▲/▼/▶/◀ ENTER	 (Play) (Pause) (Stop) (Skip) (Skip)  REC (Recording)	 Numeric keys  MENU	 FUNCTION SHIFT commands INPUT SEL.  TITLE/GUIDE	<p>Display operation</p> <p>01: Thumb Up 02: Thumb Down 03: Jump 04: Instant Replay 05: Quick Skip 06: Exit 07-11: Extend1-5</p>
--	--	---	---	--



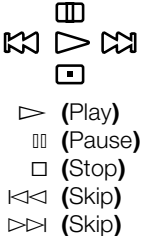
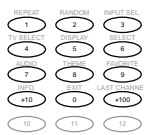



LD player operations

 + (Slow) - (Slow)  ENTER ◀◀ (Rewind) ▶▶ (Fast forward)	 (Play) (Pause) (Stop) (Skip) (Skip)	 Numeric keys  OSD/ PAGE	 FUNCTION SHIFT commands REPEAT RANDOM DISPLAY	<p>Display operation</p> <p>01: Frame/Time 02: Side A or A/B 03: Side B 04-08: Extend1-5</p>
--	--	---	---	--



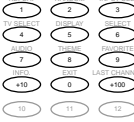





DVD player operations

 + (Fast forward) - (Rewind)  Cursor ▲/▼/▶/◀ ENTER	 (Play) (Pause) (Stop) (Skip) (Skip)	 Numeric keys  MENU  GUIDE	 FUNCTION SHIFT commands RANDOM REPEAT DISPLAY AUDIO  RETURN	<p>Display operation</p> <p>01: Chapter/Time 02: Angle 03: PGM 04: DVD Set 05: Memory 06: Clear 07: Repeat A-B 08: Sub Title 09: Title Search 10: Aspect 11: On/Off 12-16: Extend1-5</p>
--	--	---	---	--



DSS receiver operations

 <p>CHANNEL + CHANNEL -</p>	 <p>Cursor ▲/▼/◀/▶ ENTER</p>	 <p>Numeric keys</p>	 <p>FUNCTION SHIFT commands INPUT SEL. SELECT AUDIO THEME FAVORITE INFO.</p>	 <p>MENU</p>  <p>CHANNEL GUIDE</p>	<p>Display operation 01: Exit 02-06: Extend1-5</p>
---	--	--	--	---	---

Cable tuner operations

 <p>CHANNEL + CHANNEL -</p>  <p>VOLUME + VOLUME -</p>	 <p>Cursor ▲/▼/◀/▶ ENTER</p>  <p>PAGE UP (▲)</p>  <p>PAGE DOWN (▼)</p>	 <p>Numeric keys</p>	 <p>FUNCTION SHIFT commands INPUT SEL. SELECT THEME FAVORITE INFO. EXIT LAST CHANNEL</p>	 <p>MENU</p>  <p>GUIDE</p>	<p>Display operation 01: A - B - C 04-08: Extend1-5</p>
--	--	---	---	---	--

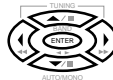
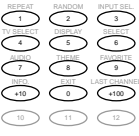





Satellite tuner operations

 <p>CHANNEL + CHANNEL -</p>	 <p>Cursor ▲/▼/◀/▶ ENTER</p>	 <p>Numeric keys</p>	 <p>FUNCTION SHIFT commands INPUT SEL. SELECT AUDIO</p>	 <p>OSD</p>	<p>Display operation 01-05: Extend1-5</p>
---	--	--	---	---	--

In case of difficulty

42

Remote control unit

Symptom	Cause	Remedy
The battery indicator flashes during operation.	<ul style="list-style-type: none"> The batteries are nearing exhaustion. 	<ul style="list-style-type: none"> Replace with new batteries to preserve the currently registered setup information. →  14
Subwoofer volume cannot be adjusted.	<ul style="list-style-type: none"> Subwoofer is OFF. 	<ul style="list-style-type: none"> Turn the subwoofer ON. →  15
Certain inputs cannot be selected using the remote control.	<ul style="list-style-type: none"> No setup codes registered at for the respective input(s). 	<ul style="list-style-type: none"> Register a setup code or Non-IR code at the respective input(s). RC →  3
Remote control operation is not possible.	<ul style="list-style-type: none"> The remote control is set to a different operation mode. Batteries are exhausted. The remote control unit is too far away from the main system, controlling angle is too large, or there is an obstacle between the receiver and the remote. The audio cords and system control cords are not connected properly. No software is loaded in the source component. An attempt is made to play a tape which is being recorded in the cassette deck. The remote control has not been set to the operation mode for the component you wish to control. The microprocessor of the remote control malfunctions. 	<ul style="list-style-type: none"> Press the MUSIC, MOVIE, or TV keys to select the appropriate operation mode. Replace with new batteries. →  14 Operate the remote control unit within the controllable range. Connect properly referring to “Setting up the system”. →  8 Place software in the source component you want to play. Wait until recording has completed. Press the MUSIC, MOVIE, or TV keys to activate the operation mode for the component you want to control before operation. RC →  5 Reset the microprocessor. →  26

For your records

Record the serial number, found on the back of the unit, in the spaces designated on the warranty card, and in the space provided below. Refer to the model and serial numbers whenever you call upon your dealer for information or service on this product.

Model _____ Serial Number _____